

GRADUATE PROSPECTUS 2024



Institute of
Space Technology





*VISION
&
MISSION*

VISION Be a National torchbearer, in the realm of academics, through quality teaching, robust research and outreach – to produce leaders in the field of Space Science and Technology, in line with National aspirations.

MISSION The institute aims at providing outstanding quality education to diverse groups of national and international students.
Academic programs focus on rigorous scientific and theoretical foundations to create professionals with thorough understanding of the fundamentals and capability of applying this knowledge for research, analysis and design.



CERTIFICATE



Management System as per
EN ISO 9001 : 2015

In accordance with TÜV AUSTRIA procedures, it is hereby certified that

INSTITUTE OF SPACE TECHNOLOGY

1 - Islamabad Highway
ISLAMABAD, PAKISTAN

Applies a Quality Management System in line with the above Standard for the following Scope

PROVISION OF EDUCATIONAL SERVICES IN TEACHING AND LEARNING, WHICH
CONSISTS OF PROGRAM REGISTRATION, EXAMINATION, MONITORING OF STUDENT
PERFORMANCES, RESEARCH AND DEVELOPMENT, TEACHING EVALUATION,
INDUSTRIAL TRAINING AND GRADUATION OF:

- AERONAUTICS AND ASTRONAUTICS ENGINEERING
- ELECTRICAL ENGINEERING
- MATERIAL SCIENCE ENGINEERING
- MECHANICAL ENGINEERING
- APPLIED MATHEMATICS AND STATISTICS.

Certificate Registration No.: 20001190002033

Valid until: 2022-07-29



Rashid Mehr
CEO
Certification Body
at TÜV AUSTRIA

Lahore, 2019-07-30

This certification was conducted in accordance with TÜV AUSTRIA auditing and certification procedures and is subject to regular surveillance audits.

TÜV AUSTRIA HELLAS
429, Mesogeion Ave.
GR-153 43 Athens, Greece
www.tuvaustriahellas.gr



C:\PKKAT_014

Headquarters in Athens bear the responsibility of the Certification decision

ISO 9001
BUREAU VERITAS
Certification

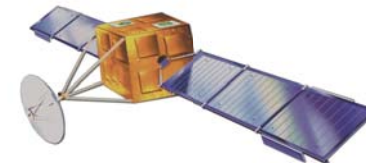

PakSat-1R
launched on 11 August 2011

ZERTIFIKAT | CERTIFICATE | CERTIFICADO | CERTIFIKAT | شهادة | 证书 | 인증서

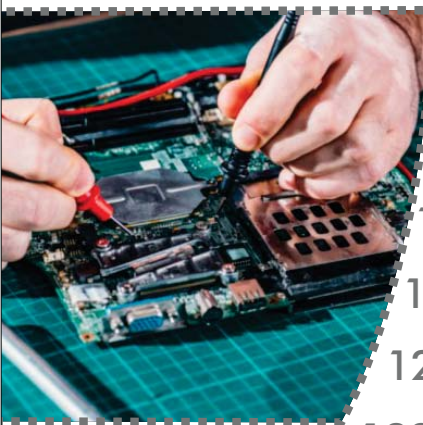
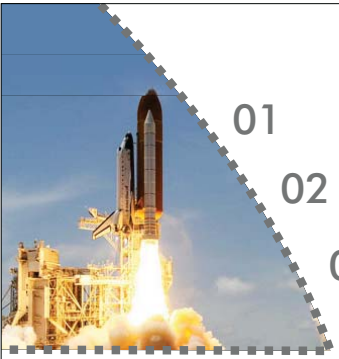

01	Welcome Message
02	Location
05	Introduction
06	The Institute
09	Students Affairs
16	Academic Programs
20	Aerospace Engineering
30	Electrical Engineering
40	Computer Science
46	Materials Science & Engineering
62	Mechanical Engineering
86	Remote Sensing & Geo-Information Science
98	Physics
102	Mathematics
117	Office of Research, Innovation and Commercialization
120	Admissions
122	Fee Structure
126	Academic Regulations
135	Faculty
144	Administration
145	Location Map

TABLE OF
CONTENTS



Vice Chancellor

IST extends a warm welcome to the new members in its community. IST offers engineering programs in the latest technologies with special emphasis on Aero Space domain. In the existing socio-economic landscape, success of nations depends on the knowledge and skills of their human resource in the cutting edge technologies which are frequently reshaping our lifestyle and surroundings. Developing a knowledge based economy will provide a strong foundation to a nation to face the challenges of the day and to take a quantum leap towards technological advancement. I am glad to inform you that IST is equipped with the expertise and resources to provide opportunities for research and innovation since its indigenous MS/PhD programs are in line with the latest developments in the technological fields.

At this stage of your academic career you are aware of the relevant knowledge and skill set which will add to your professional credentials and imbibe you with the ability to provide practical solutions to the issues of industry anywhere and particularly in Pakistan. IST will provide the support and facilities to enhance your cognitive competencies and practical proficiency, leading you on the path of creating new knowledge and making the world a better place for the coming

generations. The highly competent faculty at IST is cognizant of the significance of multidisciplinary and collaborative nature of research and has not only developed close links with the industry but has become part of research teams of reputable universities abroad.

We eagerly look forward to you joining the journey of success and accomplishment with the Team-IST.

Major General Rehan Abdul Baqi
HI(M), (Retd)

Location

Institute of Space Technology, (IST) is located in the federal capital, Islamabad. IST is at 20 minutes drive from the Zero Point of Islamabad and GPO, Rawalpindi and has multiple access through Islamabad Highway and GT Road (see map at the last page of prospectus). This advantageous location affords round the clock accessibility through public and private transportation. Being in Islamabad means that one can visit sights and places depicting the rich cultural heritage and the modern day development of Pakistan.

Islamabad: Combining a rich history, the confluence of many a civilization from the yesteryears and a temperate climate, Islamabad – the capital of Pakistan, is one of the most beautiful cities in South Asia. Wide, tree-lined streets adorn the various sectors and zones of this unique city, making it accessible, spectacular and a vibrant place.

Nestled against the backdrop of Margalla Hills at the northern end of the Potohar Plateau, the city personifies the aspirations and ambitions of a young and dynamic nation that aspires to open doors to a glorious future for its people. The city welcomes new and unique ideas but at the same time, recognizes and cherishes the traditional values and the past history of its people. Apart from the modern amenities, Islamabad is neighbor to quite a few historical sites.



Rawalpindi: Rawalpindi is a city in the Potohar Plateau near Pakistan's capital city of Islamabad, in the province of Punjab. It is also known as the twin city of Islamabad. It is the military headquarters of the Pakistan Armed Forces and also served as the nation's capital while Islamabad was being constructed in the 1960s. The city is home to many industries and factories. With historical buildings and bazaars, vast parks, chilling winters and hot summers, Rawalpindi has proven its status as a MUST visit place.

Taxila: Most of the archaeological sites of Taxila (600 BC to 500 AD) are located around Taxila Museum. For over one thousand years, Taxila remained famous as a centre of learning Gandhara art of sculpture, architecture, education and Buddhism in the days of Buddhist glory. There are over 50 archaeological sites scattered in a radius of 30 kms around Taxila. Also, a museum comprising various sections with rich archaeological finds of Taxila has been established close to the site. It is a popular destination with tourist visiting from all over Pakistan as well as abroad.



Saidpur Village: Saidpur, a little quaint village, famous for its pottery, is part of Islamabad today. It is located off the Hill Road to the east of Daman-e-Koh. Saidpur was founded by Sultan Said Khan, son of Sultan Sarang Khan. He gave his daughter in marriage to Mughal Prince Saleem who later became Emperor Jahangir. Saidpur was a garden resort and a perpetual spring provided water for drinking and for watering gardens. An attractive destination, where cultural exhibitions and restaurants provided a great ambiance among the hills during the Mughal period. It has recently been renovated into an attractive tourist destination, where exhibits and restaurants provide a great view among the hills.

Rawal Lake: To the east of Islamabad and at the foothills of Murree, lies a scenic & spectacular lake aptly named as Rawal Lake. This lake is host to many of the sporting events like, rowing, sailing and recreations like boating, fishing, sightseeing etc. Rawal Lake's primary role is to provide a water reservoir for the twin cities. Nevertheless, it is an attractive place for the visitors.



Wah Gardens: Once a major campsite of Mughal rulers, Wah Gardens is located 12 km west of Taxila on the G.T. Road. The gardens were developed with magnificent trees and water channels by successive Mughal emperors. It is a place that must be visited



Gurudwara: The town of Hasan Abdal has a particular association with Mughals and Sikhs. It was mentioned by Emperor Jahangir in his memoirs and frequently visited by successive Mughal Kings, on their way to Kashmir. It has a Sikh Gurdwara (temple) known as Panja Sahib and is visited biannually by Sikh pilgrims from all over the world.

Margallah Pass: To the North of Islamabad, Margallah lies between the ancient capital of Gandhara (Taxila), and Islamabad. There is an obelisk right on the top of the Pass, built in 1890 in memory of Brig Gen of the British army, by his colleagues. A small part of the ancient Shahi (Royal) Road built by Chandar Gupta and later developed by the Afghan King Sher Shah Suri in 1540s, can also be seen.



Murree Hills: To the further east at about 45 miles away are the green top Murree Hills. Murree is a place for all seasons; in summers it is an ideal place to beat the sizzling heat of the twin cities and a romantic hideout to catch some snowflakes during winters.

Introduction

The institute has a remarkable number of foreign trained specialized faculty who are not only dedicated but have also brought home with them years of experience from abroad.

The institute aims at offering state-of-the-art learning environment that will inculcate in students a desire to generate knowledge through innovation and research. Quality research demands advanced Labs where real world experiments are conducted; therefore, the Institute focuses on providing world class research labs. Equipments like Subsonic and Supersonic Wind Tunnel are available. IT facilities have been further enhanced with the addition of computers and Wi-Fi facility.

The Institute aspires to instill “critical thinking skills” in students through intellectual challenges posed to them that facilitate and inculcate innovative ideas. With the focus on ushering you towards the path of success in the scientific world, IST looks forward to be a mentor and conduit for you. Science is a methodical study of the space & time, an attempt to comprehend the puzzles of our universe, testing hypotheses with experiments, and then sharing what is discovered with the rest of mankind. The present era of technological advancements provided stimulus for realizing our dream: to set on a journey to explore the Universe and try to find the answers to the questions in our mind : (1) how the Universe was created? (2) how life started on the planet earth? and (3) does life exist on any planet other than the earth? The space exploration has created an ecosystem where cutting edge technologies are conceived, researched and eventually developed. There has been an exponential increase in scientific discoveries in the past century and we are only at the leading edge of a vast wave. In this milieu, Institute of Space Technology (IST), Islamabad, was established in September, 2002. Being the only institute of its kind in Pakistan, it strives to impart specialized education in space and related science. At IST, we offer graduate degrees in Aerospace, Electrical, Mechanical, Materials Science & Engineering, Computer Science, Global Navigation Satellite Systems, Remote Sensing and Geo-Information Science, Astronomy & Astrophysics, Physics, Statistics and Mathematics.



Academic Block I

Amidst the green spaces a spacious purpose-built, double storied, centrally air conditioned building with a covered area of 5384 sqm, houses administrative and faculty offices, class rooms, lecture theatres, teaching and research laboratories, Information Technology Center, library, conference room, auditorium, faculty lounge and exhibition area.

Video Conferencing Facility

A state-of-the-art video conferencing facility is available in the Academic block I. The facility is useful for distance learning and telecasting lectures to and from other universities with similar facilities.

Academic Blocks II to VI

Academic Blocks II & VI are also available to house additional classes and laboratories. The Blocks are air-conditioned to support a conducive learning environment.

Auditorium

Aesthetically designed, fully air-conditioned auditorium with a capacity of 230 persons is located adjacent to the entrance lobby of the Academic Block-I. An ideal venue for holding national and international conferences, seminars, and workshops, it is equipped with modern audio-visual systems.

Campus

Away from congestion, noise and pollution of the city, at 20 minutes drive from Islamabad and Rawalpindi, having multiple access through Islamabad Highway and GT Road, IST is located in the Capital Territory of Pakistan. This advantageous location offers round the clock accessibility through public and private transportation. Spanning over 577 kanals of picturesque expanse of greenery adjacent to DHA, the campus features wide lawns, ample parking spaces and playgrounds. This tranquil environment makes it ideal for situating a seat of higher learning and research.



Lecture Theatres

All lecture theatres and classrooms are centrally air-conditioned, well-lit and equipped with training aids and multimedia facilities. Lecture theatres can accommodate 60 students, whereas classrooms have a seating capacity of 30 students.

Computer Theatres

Classrooms with individual computers for each student are available for computer based training. The computers are networked to a server and an overhead multimedia projector to enable interactive, hands-on training on computational and professional software learning skills. A computer laboratory housing powerful computers is available for assignments and projects. Also, internet facility is available to students at all times of the day.

Specialized Laboratories

The academic program is supported by laboratories equipped with state-of-the-art equipment. Multiple equipment and instruments are available to ensure hands-on training of each student in the following laboratories:

- Aerodynamics
- EMF & Microwaves
- Mechanics of Materials
- Antennas & Propagation
- Propulsion
- Optical Communications
- Control Systems
- Digital Design

- Aerospace Materials
- Electronics
- Finite Element Methods
- Communication Systems
- Computational Fluid Dynamics
- Computer Networks
- Aerospace Instrumentation
- Electrical Circuits
- Information Technology
- Embedded Systems
- Computer Aided Design
- Digital Signal Processing
- UAV Design Lab
- Digital Communications
- Workshop
- Mobile Communications

Library

The library is integrated with digital technology and electronic information resources. There is an active and continuous development program for the IST library. It has a dynamic collection of books, journals and magazines related to all disciplines which is supplemented by a Xeroxing facility. The core design, furniture and general decor contribute to the formation

General Collection: IST library has a collection of more than 13,000 books on all subjects relevant to the courses taught at the institute. Moreover, books on general knowledge, Islam, history, geography and fiction etc are also available.

Reference Section: The reference section has over 840 reference

books, handbooks, encyclopedia and dictionaries etc.

Periodicals: IST library is currently subscribing to 17 periodicals to meet the requirements of researchers, faculty and students.

Audio Visual Collection: Audio-visual material is considered an essential medium of instruction. Library has a good collection of educational videos and related audio/visual devices.

Online Resources: To enrich the library collection with the latest online resources available through Internet, professional publications from AIAA, IEEE, ACM and IMechE are accessible.

More than 23,000 journals are available (full text) through HEC Digital Library Program

Equal Opportunity Institution

IST is an equal opportunity institution and prohibits discrimination on the basis of race, color, national origin, sex, religion, age, disability, political beliefs, marital or family status in all its programs and activities.

Timings

Evening Classes

Medium of Instruction

The medium of instruction at IST is English.

Facilities

Hostel

Hostel accommodation is available for female students within campus. IST provides pick& drop facility from hostels to campus & shuttle service for markets. Dining facility is available and the boarders enjoy the tranquility and fine meals of the mess. Hostels are equipped with backup generator to provide continuous supply of electricity. All the hostels are furnished with free internet facility. Hostels have a conducive environment for boarding & lodging of students.

Computing

A large number of computers are available at convenient locations for students to do their assignments and projects. Moreover, wireless internet facility is also available to students to connect to the internet from anywhere in the campus.

Sports & Games

Students can avail spare time to enjoy a game of table tennis in the table tennis room or perfect their shooting in the basket ball court. Also, there are numerous indoor games that students can enjoy at their leisure time.

Fitness

For the fitness conscious, a fitness room with multiple fitness and exercising equipment is available.

Mosque

The mosque, adjacent to the academic block and dormitory hosts regular prayers. Namaz-e-taraveeh is also held during the month of Ramadhan.

Commuting

Pick and drop facility is available for day scholars from convenient points in Rawalpindi and Islamabad. A weekly service to city centers is also available for boarders on weekends.

Cafeteria

A spacious, air-conditioned cafeteria is available for students and faculty to enjoy meals at economical rates. The quality of food available at the cafeteria is routinely monitored to ensure quality of food products.

Reproduction Room

A Xeroxing, binding, scanning & printing facility is available within the campus which provides services at subsidized rates.

Medical Aid

A health centre is available in the campus which is manned by a qualified nursing staff during the working hours. In case of minor problem, adequate arrangements are available to provide the first aid. However, an ambulance is available round the clock to take serious patients to the hospital.



development
 faculty awareness
 semantics discernment
 potential facts consclo
 power
 International Linked Chapters
 Alumni Affairs
 Academic Societies
 Internships



value
 science
 sense
 brilliance
 global attitude
 discipline attention
 observation
 enlightenment graduate
 proficiency
 curriculum

Career Counseling



Placements



Department of Student Affairs



Societies and Clubs

Awards Ceremony
 Outreach

Discipline
 Media

Sports

Department of Student Affairs (DSA) facilitates students in domains that complements their academics in student life. The major areas of Department of Student Affairs include internships, placements, alumni affairs, student societies' events and activities, sports and annual awards ceremony.

Internships

Department of Student Affairs shares internship opportunities with the students of IST and also encourages them to identify internship opportunities suited to their career aspirations. DSA assists students in securing these additional opportunities so that the students may undertake the much needed industrial exposure during their degree programs.

Placements

Technically sound and managerially efficient graduates of IST are ranked among top professionals by numerous employers. We strive for the best placement opportunities for our graduating students. A yearly 'Graduates Book' is developed that encompasses graduating students' profiles with project abstracts. This book is shared with many reputed employers from public and private sector during the Open House. Open House is an annual activity of IST and numerous employers from Public and Private Organizations are invited to provide an opportunity of

employment to the graduating students.

Alumni Affairs

Alumni are a benchmark of the success of any institute. Institute of Space Technology has produced graduates with specialized degrees in Aerospace, Communication Systems, Electrical, Mechanical, Materials Science and Engineering, Space Science, Remote Sensing & GIS, Astronomy and Astrophysics, Mathematics and Global Navigation Satellite Systems (GNSS) at undergraduate, post graduate and doctoral level. IST's alumni are currently serving at various nationally & internationally renowned industries and organizations. Prompting an affianced, supportive alumni network is crucial to an institution's success.

Alumni reunions are excellent way of promoting networking amongst the alumni, current students and the alma mater. Department of Student Affairs strives to provide the platform of reunion to its Alumni by managing Alumni Gatherings.

IST Student Societies and Clubs

Academic Societies and Clubs

- **American Institute of Aeronautics and Astronautics (AIAA) - IST Chapter**

AIAA is a promising platform that provide incentives for students to

undertake hands-on work in the aerospace field. AIAA-IST chapter collaborates with relevant industries to support students in research findings at the national and international level. Organizing seminars and workshops with other aerospace related institutions and offers students the opportunity to join international associations, allowing students to connect with professionals in the field around the world.

- **American Society of Mechanical Engineers (ASME) – IST Chapter**
ASME and is a global association that promotes the dissemination of education, knowledge and the respective skills required for the research and development for the discipline of engineering. This society is focused on mechanical engineering. ASME has over 110,000 members in more than 150 countries worldwide. As a society different competitions and workshops are hosted so that the students may acquire skills outside the classroom.

- **Institution of Mechanical Engineers (IMechE) – IST Chapter**
Institution of Mechanical Engineers (IMechE) is a global association that promotes mechanical engineering and its applications in different industries. IMechE has over 120,000 members in as much as 140 countries worldwide. The student chapter of IMECHE at IST strives to

provide students with opportunities to get guidance from top professionals in the relevant industries.

- **Institute of Electrical and Electronics Engineers (IEEE) - IST Chapter**

IEEE is a non-profit and multi-disciplinary organization with 10 regional setups. Pakistan is part of region 10 and IST affiliates with IEEE Islamabad section. The main objective of this IEEE – IST Chapter is to facilitate and motivate the students of IST towards technology that will enhance their technical and professional skills in the field of Electrical and Electronic Engineering.

- **Material Advantage Chapter - IST (MAC)**

This society provides an opportunity for the young learners to discover their skills and explore new horizons in Materials Science and Engineering. In order to incorporate these qualities in the students, the society arranges multiple activities through its club such as materials research, seminars, workshops etc.

- **American Society of Heating, Refrigeration and Air-Conditioning Engineers (ASHRAE) – IST Chapter**

ASHRAE advances the arts and sciences of heating, ventilation, air conditioning and refrigeration to serve humanity and promote a sustainable world. Students

interested in multiple fields including indoor air quality, building design and operation, and environmental control for food processing and industry usually find a sanctuary under the umbrella of this chapter.

- **IST Google Developers Club**

Google Developer Student Clubs (GDSCs) are community groups for university students interested in Google technologies and Tech communities. The club's main purpose is to Connect, Learn and Grow Students. Connect by meeting students interested in developer technologies and technical communities. Learn about various technical topics and gain new skills through hands-on workshops, events, talks, and project-building activities. By joining a GDSC, students grow their knowledge in a peer-to-peer learning environment and build solutions for local businesses and communities.

- **IST Space Society (ISS)**

Google Developer Student Clubs (GDSCs) are community groups for university students interested in Google technologies and Tech communities. The club's main purpose is to Connect, Learn and Grow Students. Connect by meeting students interested in developer technologies and technical communities. Learn about various technical topics and gain new skills through hands-on workshops,

events, talks, and project-building activities. By joining a GDSC, students grow their knowledge in a peer-to-peer learning environment and build solutions for local businesses and communities.

- **IST Robotics Society**

The objective of IST Robotics Society is to support the development and exchange of scientific knowledge in the fields of robotics and automation. It provides the students a platform to explore and indulge in engineering knowledge and have hands on experience in the field of robotics, automation and artificial intelligence.

- **IST Geospatial Society**

By connecting Pakistanis with various GIS data and technology providers, such as ESRI, OSGeo, and others, the Geospatial Society hopes to play a small part in the spread of pure GIS and obtain the resources necessary to give students a better working environment and platform to use its creativity in GIS. The platform is to educate people about new technologies, provide them with free and useful data to work with, and encourage them to develop geospatial applications.

- **IST Mathematical Society**

The goal of the IST Mathematical Society is to promote and advance

the discovery, learning and application of mathematics. The IST Mathematical Society reaches out to and develop new partnerships with the users of mathematics in universities, educators in the school and college systems, as well as other mathematical associations. IST students participated in International Kangaroo Mathematics Contest (IKMC) 2022 secured 1st, 2nd, 3rd, 4th and 5th positions among 37 students in Pakistan. IST stood first in Pakistan with the mentioned accolades.

- **Artificial Intelligence Community of Pakistan (AICP) – IST Chapter**

The community is built with the ambition to provide skills, knowledge, and experience in the field of AI to our student community. Our mission is to equip students with the necessary tools and resources to excel in the field of artificial intelligence. The chapter organizes events, workshops and seminars for the students of IST.

- **Association for Computing Machinery – IST Chapter**

The platform provides students with the opportunity for networking, learning and sharing knowledge related to the field of information technology, computing machinery and computer science. Its mandate is to organize tech oriented workshops, webinars symposiums and field visits.

- **American Chemical Society – IST Chapter**

The American Chemical Society International Chapter at the Institute of Space Technology is dedicated to fostering a vibrant academic and research environment for its members. This esteemed chapter offers its students unparalleled opportunities to engage in specific research endeavors. Additionally, the chapter is committed to the intellectual growth and professional development of its members through workshops and seminars on advance science and engineering.

Extra-Curricular Societies and Clubs

- **IST Green Youth Movement (GYM) Club**

Green Youth Movement Club IST Chapter was established in 2021 under the Prime Minister's Youth Program "Clean and Green Pakistan" aims at tackling climate change and sensitizing the youth to contribute towards environmental conservation and promote eco-friendly behavior among people. This society assists university administration in formulation, monitoring and implementation of policies pertaining to environment. It also works to create awareness regarding the significance of environmental sustainability of IST and encourages young people to conserve nature by spreading

awareness and conducting different activities for environmental protection within campus and outdoor. The GYM club is to make IST a better place where every student of IST is an environmentalist, and knows that their every little action count in making our home planet - Earth close to its nature.

- **IST Entrepreneurial Society (IES)**

IST Entrepreneurial society strives to create success in blazing a path of innovation for its members. Initiating new entrepreneurial ideas and producing employers rather than employees is the core aspect of this society. Students with a mindset of thinking out of the box and are committed to create opportunities for people, are encouraged to be a part of this entrepreneurial setup.

- **IST Literary and Cultural Society (ILCS)**

IST Literary and Cultural Society garners and patrons the student literary, artistic and cultural ambitions. The society promotes creative writings, facilitates publishing of poetry, prose work, and holds meetings with renowned authors and culture-icons who nourish the participants with their experiences and skills. In addition, society organizes events to revive the esteem of Urdu and regional languages in Pakistan along with the festivity of national heritage of

culture. The society organizes Heritage Gala annually to promote native languages and inter-cultural harmony.

- **IST Debating Society**

IST Debating Society aims to provide a platform where the student body can develop and showcase their Oratory and Debating skills. It allows students to master the art of speaking in public domains by engaging them in various activities and competitions. It allows them to indulge into the improvement of their Declamation and Debating skills in both Urdu and English Language and provides them with the skill-set required to vocally express their opinions on public platforms.

- **IST Arts Society-ArtIST**

The society operates with a vision to enhance creativity and talent of the students. The platform helps students to create a balance in their personality and express their imagination through art. It helps students to explore their innovativeness thereby maintaining a healthy environment.

- **IST Music Society - GOONJ**

GOONJ - The Music Society at Institute of Space Technology (IST) is a dynamic platform for students to showcase their talents and explore their love for music. Regularly organizing music events, competitions, and jamming sessions, the society strives to

promote and encourage music among students, while also creating opportunities for collaborations and fostering a deeper understanding of different music genres.

- **IST Performing Arts Society - AOUJ**

This society aims at promoting the significance of the performing arts in personal development of IST students. The society provides a platform to students to showcase their talents such as acting, script writing, communication and teamwork. Dramas, short plays and skits have always been regular features of the IST Dramatics Society. AOUJ organizes a yearly intra-university dramatics competition, to provide an opportunity to students to present their acting and performing skills to the audience.

- **IST Youth Club (IYC)**

IST Youth Club's mandate is to celebrate/ observe National and International days at IST. IYC aims to promote nationalism and patriotism in students of IST by organizing Pakistan Day, Independence day, Defense Day, Kashmir day, Yum-e-Taqbeer, Iqbal Day, Quaid Day, Labour Day etc.

- **IST Media Club (IMC)**

The IST Media Club team prides itself on harboring great talent in many different fields such as photography, videography, graphic

designing and content production. Each member of the society possesses a dedicated and innovative spirit towards the work needed for different areas. IST Media Club collaborates with other societies within IST in addition to organizing their own independent media related events and workshops. The aim is to make each event an unforgettable experience for everyone and to make memories that will last forever. It conducts a Media Fest, an annual event where students are given an opportunity to demonstrate their media related skills.

- **IST Character Building Society (CBS)**

IST Character Building Society (CBS) encourages students to develop an environment that supports the students to acquire and practice high moral values and a strong sense of responsibility towards their fellows and society in general. Main objectives of the society are to promote and create awareness of the strong character attributes, moral and ethical values. Also to promote mutual respect and tolerance by inculcating disciplinary policies of IST pertaining to professional and personal development of the university students.

- **UMEED – IST Social Welfare Society**

UMEED, the educational awareness and community building society is

run by the students of Institute of Space Technology and was awarded third prize at the 2016 Yousif Badri Civic Engagement International Competition. UMEED provides continuous material support to fifty rural area government schools and their students. UMEED has undertaken various welfare projects in these schools since its inception in year 2010. IST Student and President of UMEED "IST Social Welfare Society" Ms. Laiba Zahid of Materials Science and Engineering was honored with the "Flood Hero Award" in recognition of team UMEED's efforts to help flood-affected people. The award was presented to her in the Prime Minister's Secretariat on December 5, 2022. UMEED works in the areas of education, health, safe water and disaster mitigation. With efforts increasing each day, UMEED strives to eliminate the hurdles in the path of basic education of the under privileged.

- **IST Islamic Research Society**
IST Islamic Research Society promises the development of a friendly environment to promote the teachings of Islam at Institute of Space Technology. It aims to promote the concept of religiosity in the light of Quran and Sunnah. In order to accomplish its objectives, IST Research Society organizes guest talks, Arabic course, Hadith

course and research circles.

- **IST Sports Society**
To relieve the academic pressure, sports are an integral part of the co-curricular activities at IST. A series of inter-departmental tournaments are held periodically throughout the year to facilitate participation of maximum number of students. IST Sports Society is responsible for conducting and facilitating all sports activities at IST, as well as training students for various intervarsity tournaments and for national level tournaments.

- **IST Tennis Club**
Tennis is a sport requiring staunch determination, technique & precision. IST Tennis Club aims to encourage healthy competition amongst students by organizing & conducting tennis tournaments throughout the academic year, as well as promoting tennis at IST and facilitating students with the right training to excel in the game.

- **IST Chess Club**
IST Chess Club aims at the intellectual development of the students of IST promoting an environment of learning and competition in the beautiful game of chess. Comprising three of the top ranked players of the country, we plan to develop and polish the skills of all newcomers through our influential classes and amazing tournaments. Affiliated with the

"Chess Federation of Pakistan" we have the necessary support to succeed in every chess endeavor.

- **IST Adventure Club**
IST Adventure Club aims to promote hands on personal experience through various events and providing a safe yet fun environment. The club aims to bring adventure oriented events and trips to different locations throughout the year. Our events bring students together in challenging activities, encourage teamwork among themselves, and by interacting and appreciating the nature and beauty of our country

Sports

Importance of sports in the life of a student is invaluable and goes much further than the basic implied stereotypes. We believe that sports are one of the best ways to develop skills like leadership, team playing and strategy building. IST holds multiple sports competitions among its departments to promote healthy competition among the students. These sports include Football, Cricket, Basketball, Volleyball, Tennis, Badminton, Table Tennis, Tug of war and Futsal. In addition to the interdepartmental sports activities, students are provided ample opportunities for routine sports activities during their free time during and after university hours. Departments are awarded

points for winning interdepartmental sports, which contribute to the overall championship points of the respective departments each year.

Annual Awards Ceremony

Department of Student Affairs holds an annual awards ceremony to acknowledge the accomplishments of students in co-curricular and extra-curricular activities. Students are awarded with medals, trophies and certificates for their extraordinary achievements. These awards are primarily distributed not only to recognize the hard work of the student but to instill a sense of acknowledgment and accomplishment in the students.

Student Discipline

IST expects its students to uphold the utmost standards of honesty, integrity and discipline. Keeping in perspective the values of IST, a disciplinary committee is set in place which is coordinated by the Department of Student Affairs. In case of violation of student discipline, IST disciplinary committee reserves all rights to take any action against the concerned.

MS PROGRAMS

AEROSPACE ENGINEERING

- Aerodynamics & Fluid Mechanics
- Aerospace Structures
- Aerospace Propulsion
- Flight Dynamics & Control Systems

ELECTRICAL ENGINEERING

- Wireless Communications
- Signal & Image Processing
- Electronics & Embedded Systems
- RF & Microwave
- Satellite Systems Engineering

COMPUTER SCIENCE

- Artificial Intelligence & Computer Vision
- Cyber & Information Security

MATERIALS SCIENCE & ENGINEERING

- Aerospace Materials
- Nano-engineering Materials
- Functional Materials
- Coating & Tribology

MECHANICAL ENGINEERING

- Mechanical Design & Analysis
- Fluid & Thermal Systems
- Manufacturing System

MATHEMATICS

- Applied Analysis
- Nonlinear Dynamics
- Algebra / Algebraic Geometry
- Fluid Mechanics
- Computational Mathematics
- Cryptography

PHYSICS

- Computational Materials Science
- Supermassive Black Holes
- High Energy Astrophysics
- Energy & Smart Materials
- Thermoelectric Materials
- Optoelectronic Materials
- Galaxy Mergers
- Particle Astrophysics
- Gamma-Ray Bursts
- Space Plasma
- Cosmology
- Gravitational Waves

REMOTE SENSING & GEO-INFORMATION SCIENCE

- Photogrammetry
- Remote Sensing
- Geographic Information Science
- Climate Modeling
- Hazard & Disaster Management
- Water Resources Modeling

PhD PROGRAMS

AEROSPACE ENGINEERING

- Aerodynamics & Fluid Mechanics
- Aerospace Structures
- Aerospace Propulsion
- Flight Dynamics & Control Systems

ELECTRICAL ENGINEERING

- Wireless Communications
- Signal & Image Processing
- Satellite Engineering
- Antennas and RF / Microwave
- Information & Cyber Security
- Electronics & Embedded Systems
- Computer Vision

MATERIALS SCIENCE & ENGINEERING

- Aerospace Materials
- Nano-engineering Materials
- Functional Materials
- Coating & Tribology

MECHANICAL ENGINEERING

- Mechanical Design & Analysis
- Fluid & Thermal Systems

MATHEMATICS

- Nonlinear Dynamics
- Algebra / Singularity Theory
- Fluid Mechanics
- Computational Mathematics
- Applied Analysis

The programs are structured in a manner to prepare the engineering students for a career with wide ranging opportunities in research, design, development, production, management and solutions development related to aerospace and communication technologies in the fast growing aerospace and telecommunication, wireless and satellite industry.

Future in Aerospace Engineering

The field of aerospace technology offers a wide range of employment opportunities to those with the proper educational background. An aerospace team is made up of engineers, scientists, and technicians. Positions are available through the private sector as well as within the government sector. Examples of major engineering roles in the aerospace industry include:

- Analysis
- Design
- Materials and Processes
- Systems Engineering
- Software Development
- Manufacturing
- Flight Research

Future in Electrical Engineering

MS Electrical Engineering is a research based master's program offered by IST. This program

provides students with an opportunity to gain deeper understanding of various specializations like Communication systems, RF & Microwave systems and the signal processing algorithms commonly employed in various fields. The versatility of the program allows the students to tailor the course work according to their research area of interest while providing them with a solid foundation in fundamental principles. With the changing trends of research and job market, this program will bring students at par on the current state of the art and provide them with

tools to stay abreast with the future developments. Previous graduates of the program are employed in telecommunication, aviation and research & development industry of Pakistan. A significant percentage of the graduates go abroad for further studies and continue a career in academia.

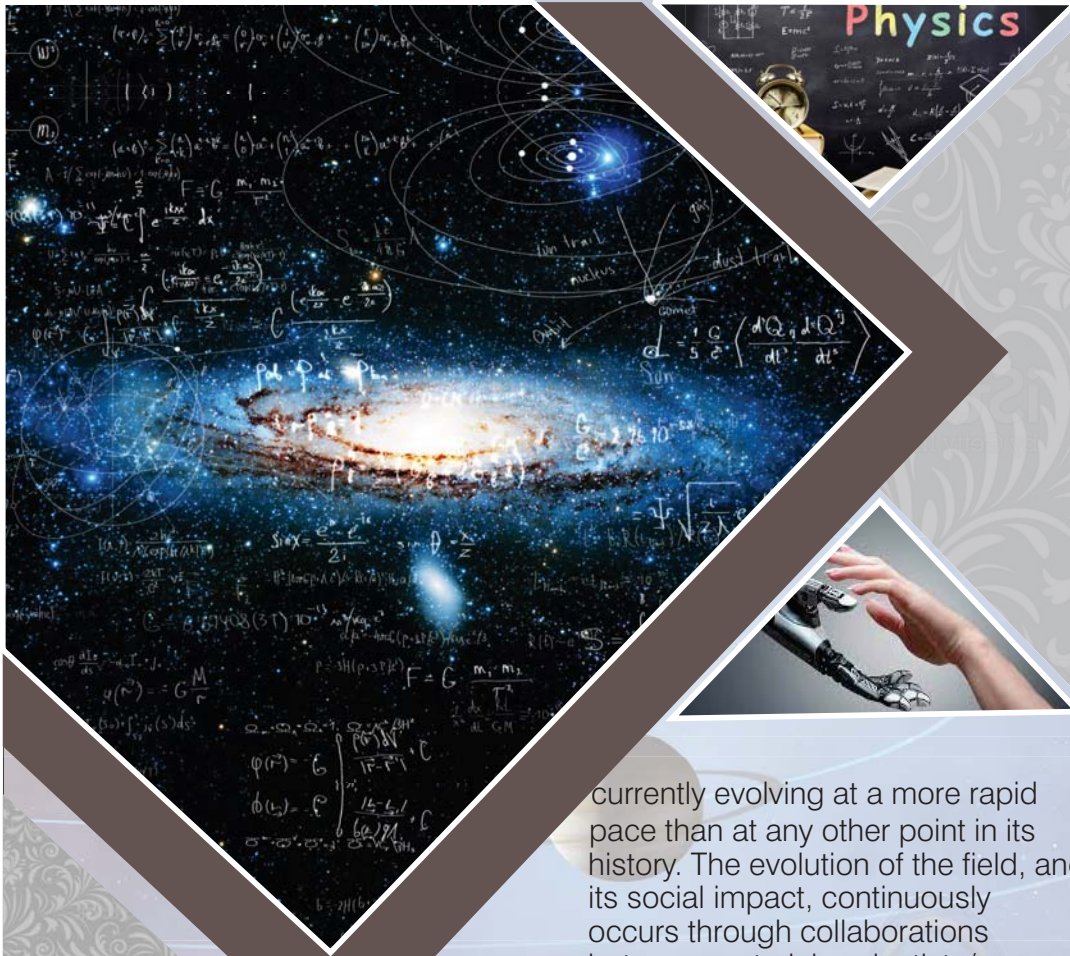

Future in Materials Science and Engineering

Materials Science and Engineering (MS&E) has played a pivotal role in the technological evolution of our society, from structural steels to optoelectronics and information processing. The field of MS&E is

currently evolving at a more rapid pace than at any other point in its history. The evolution of the field, and its social impact, continuously occurs through collaborations between materials scientists/ engineers and a researcher from fields such as biology, medicine, physics, chemistry and other areas of engineering and manufacturing. Most fields in science and engineering are concerned in some way with materials, but only the field of materials science and engineering focuses directly on them. Further, the materials play an important role to provide solutions to the major challenges in fabricating

nanotechnology based devices. So a wide variety of opportunities await the materials science and engineering graduate in research, development, design, production and management in almost every industry.

Future in Mechanical Engineering

Department of Mechanical Engineering offers studies leading to the degree of Master in Mechanical Engineering, preparing young engineers for a wide range of exciting opportunities including aerospace, manufacturing, automotive, chemical, biomedical, nuclear power, robotics, textiles, R&D, administration and management. The curriculum includes the methodical tools, innovative thought, communication skills, management tools, and provide young engineers the opportunities to work efficiently as individuals and in teams. The structure and sequence of courses is designed to ensure that every graduate has the knowledge, ability and understanding required for value education.

The main focus of this degree program is on the following specialized areas:

- Fluid and Thermal Systems
- Mechanical Design and Analysis
- Manufacturing Systems
- Dynamic and Control
- Automobile

Future in Physics

Physics investigates the laws of nature and is indispensable not only for our understanding of the world but also for the solution of the technological and ecological problems. As a fundamental science, physics continues to be the driving intellectual force in expanding our understanding of the universe, in discovering the scientific basis for new technologies, and in applying these technologies to research. Students completing this program shall acquire broad knowledge and skills to work in various organizations looking for physicists. Scope for our graduates will be in strategic organizations of Pakistan and public/private universities as well as organizations. The graduates can also pursue higher studies at national/international universities and research organizations.

Future in Remote Sensing & GISc

The MS and PhD programs in Remote Sensing and Geographical Information Science are designed for imparting expertise in the science, methods, and applications of these rapidly growing fields. The job market is vast and varied, with the growing need for experts in these fields in both the government and commercial sector. The nature of possible careers is spread over a wide canvas: research, planning

and development, advising the decision-makers, the application and service providing sector. Some of the options include Agriculture (crop planning, crop health monitoring, yield forecasting), Natural Resource Management, Geology (mineral exploration, earthquake prediction and mapping), Water Resources: (snow melt monitoring and melt-water estimation, flood mapping, monitoring and prediction, irrigation planning and monitoring), Urban Planning and Monitoring (city planning, transportation & utility network planning), Revenue and Tax Collection, Mapping, Meteorology and Climatology, Environment,

Navigation and Tracking Applications, Location-based Services, Social Sector (healthcare, public services, criminology), Real Estate.



Aerospace Engineering



The Department of Aeronautics and Astronautics maintains an internationally recognized academic program in aerospace engineering by engaging all stakeholders through an open dialogue. The major stakeholders are: students,



faculty, industry and aerospace professionals. The result of this

consultative process is reflected in continuously improving the academic improvement to provide the best possible education to our students.

The aerospace engineer is primarily concerned with the design, analysis, testing and



overall operation of aerial vehicles. The curriculum is designed to educate the students in the fundamental principles of aerodynamics, flight dynamics, propulsion, structural mechanics, flight controls, design, testing and space technologies. A wide variety of opportunities await the aerospace engineering graduate in research, development, design, production, sales and management in the aerospace industry and in many related industries

Mission Statement

The mission of the Aerospace Engineering Program is to prepare the engineering student for a career with wide-ranging opportunities in research, development, design, production, sales and management in the aerospace industry and related industries which are involved with the solution of multi-disciplinary, advanced technical problems.

Programs Educational Objectives

- Produce Aerospace Engineers with a strong practical and theoretical exposure in the relevant disciplines, who are able to contribute to society through innovation, enterprise and leadership
- Nurture engineer with a global outlook and to provide technological leadership through necessary technological tools
- Produce engineers with teamwork, communication and interpersonal skills
- Enable them to be productive members of interdisciplinary engineering teams and are further capable to adopt to changing environments of engineering, technology and society
- Produce engineers with high moral and ethical values
- Inculcate critical thinking among students and develop initiatives and innovative ideas

Aerospace Engineering

Aerospace engineering is a field where state-of-the-art technologies are applied everyday. It is an exciting profession with outstanding career opportunities in which physical sciences, mathematics and computers are combined in the design of air and space vehicle systems and components to achieve high performance with limited size and weight. This requires aerospace engineers to constantly develop and apply the most advanced technologies. Aerospace technology has grown out of the problems of design, construction and operation of vehicles that orbit above the Earth's surface (vehicles ranging from ground-effect machines to aircraft and spacecraft). Design of such vehicles has always been challenging, not only because of the requirement that they operate in a hostile environment, but also the high

premium placed on light weight, high efficiency and great reliability. These requirements are not only relevant to future spacecraft and high performance aircraft, but also to the next generation of ground transport vehicles.

Prerequisites

- BE/BS with strong background in Aerospace, Aeronautical, Avionics, Mechanical, Electrical, Mechatronics, Chemical, Manufacturing or Materials Science & Engineering with minimum CGPA ≥ 2.00 out of 4.00 or $\geq 60\%$ marks (where CGPA not available) from HEC and PEC recognized (where applicable) Institute/University or from Foreign Institute/University of good repute
- GAT-A (General) conducted by NTS in the relevant field of study with $\geq 50\%$ marks or HAT (General) conducted by HEC in the relevant field of study with $\geq 50\%$ marks or GRE International (General) conducted by ETS, USA, with minimum score as Quantitative: 150, Verbal: 150, Analytical: 3.5

The IST institutional code to receive GRE scores is 1758



The graduate program has been configured so that each student has adequate knowledge of the core specialties of the Aerospace engineering program. In this regard the compulsory courses are in compliance with the above requirement. In addition, the elective courses are configured so that the student can attain sufficient depth

in the specialty of their choice within the domain of Aerospace Engineering.

All enrolled students enrolled in the MS Aerospace Engineering program will study the following courses irrespective of the specialization of their choice,

Course Type	Sub-specialization Groups			
	Aerodynamics/Computational Fluid Mechanics	Aerospace Propulsion	Aerospace Structural Design and Analysis	Flight Dynamics and Control System
Breadth	<ul style="list-style-type: none"> • Flight Dynamics or any other breadth course of Flight Dynamics and Control System • Mechanical Behavior of Materials or any other breadth course of Aerospace Structural Design and Analysis • Advanced Heat and Mass Transfer or any other breadth course of Aerospace Propulsion • Incompressible Aerodynamics or any other breadth course of Aerodynamics/Fluid Mechanics • Advanced Numerical Techniques (Mathematics) or any other breadth course of Mathematics 			
Depth	<ul style="list-style-type: none"> • Aerodynamics/Fluid Mechanics Elective I • Aerodynamics/Fluid Mechanics Elective II • Aerodynamics/Fluid Mechanics Elective III 	<ul style="list-style-type: none"> • Aerospace Propulsion Elective I • Aerospace Propulsion Elective II • Aerospace Propulsion Elective III 	<ul style="list-style-type: none"> • Aerospace Structural Design and Analysis Elective I • Aerospace Structural Design and Analysis Elective II • Aerospace Structural Design and Analysis Elective III 	<ul style="list-style-type: none"> • Flight Dynamics and Control System Elective I • Flight Dynamics and Control System Elective II • Flight Dynamics and Control System Elective III
Research	<ul style="list-style-type: none"> • Thesis I • Thesis II 			
Extra	Research Methodology (Non-Credit)			

Please note that the electives list (shared under the electives heading) will be offered based on the availability of the relevant faculty. However, a student may opt to study courses from other departments as advised by the research supervisor based on the needs of the students' research project.

Elective Courses

The students can select from following list of elective courses. These electives are combined of all specialization offers under “Local MS Programs” in MS Aerospace Engineering.

Aerodynamics/Fluid Dynamics

- Advanced Compressible Flows
- Computational Fluid Dynamics
- Viscous Flow
- Turbulent Fluid Flow
- Unsteady Aerodynamics
- Experimental Aerodynamics
- Hypersonic Aerodynamics
- Advanced Aerospace Vehicle Design

Or any other depth course of Aerodynamics/ Fluid Dynamics

Flight Dynamics and Control Systems

- Linear Systems Theory
- Spacecraft Dynamics & Control
- Control System Design
- Estimation of Dynamic Systems
- Modern Methods in Aircraft Flight Control
- Nonlinear Control
- System Identification
- Robust Control
- Digital Control
- Aerospace Guidance and Navigation
- Spacecraft Attitude Determination & Control

Or any other depth course of Flight Dynamics and Control Systems

Aerospace Propulsion

- Turbomachinery
- Aerothermodynamics of Gas Turbines and Rocket Propulsion
- Gas Turbine Theory and Performance
- Aircraft Engine Design
- Mechanics and Thermodynamics of Propulsion
- Propulsion System Performance and Integration
- Rocket Propulsion
- Advanced Aerospace Propulsion
- Advanced Combustion
- Advanced Materials in Engineering

Or any other depth course of Aerospace Propulsion

Aerospace Structural Design and Analysis

- Advanced Materials in Engineering
- Advanced Structural Dynamics
- Aeroelasticity Theory
- Theory of Plasticity
- Advanced Mechanical Vibrations
- Finite Element Method
- Engineering Mechanics of Composite Material
- Fracture Mechanics
- Advanced Mechanics of Materials
- Theory of Elasticity
- Smart Structures
- Structural Design of Launch Vehicle and Reentry Vehicles

Or any other depth course of Aerospace Structural Design and Analysis

Course Description

Aerodynamics (supersonic) (3-0)

Theory of supersonic flow, formation of bow shock and oblique shock wave, aerofoil shapes for high speed flight, aerodynamic shapes of bodies for high speed flight, concept of lifting bodies, compressibility effect, aircraft handling requirements at supersonic speeds

Flight Dynamics (3-0)

The course includes dynamics and control of aircraft, Linear systems theory, state equations, transfer functions, stability, time and frequency response, Aircraft longitudinal and lateral flight dynamics

Computational Fluid Dynamics (3-0)

Classification, implicit & explicit methods, iterative & time/space marching schemes, grids, boundary conditions, aerospace applications, Finite-difference; finite volume methods for solution of Navier-Stokes & Euler equations, Classification of partial differential equations and solution techniques. Truncation errors, stability, conservation and monotonicity, Differencing strategies. Advanced solution algorithms, Grid generation, Construction of complex CFD algorithms, Current applications, Use of CFD codes

Viscous Flow (3-0)

Laminar boundary-layer theory, three-dimensional and compressible

boundary layers, Laminar-flow instability theory, transition, Introduction to the mechanics of turbulence, turbulent free shear flows and boundary layers, Computational and general solution methods, Stability of laminar flows, transition and turbulent flow

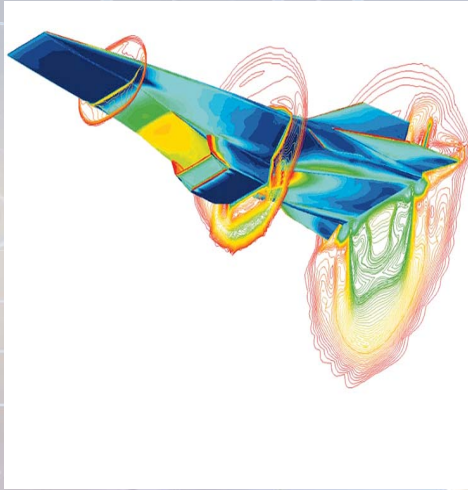

Turbulent Fluid Flow (3-0)

Description of turbulent flow, Flow equations, vorticity dynamics, Reynolds-averaged equations, engineering turbulence models, Theory of homogeneous turbulence, spectral dynamics, Shear flow turbulence, mean and fluctuating structure of free and wall-bounded turbulent flows Qualitative features of turbulence, Statistical and spectral representation of turbulent velocity fields, averages, moments, correlations, length and time scales and the energy cascade, Averaged equations of motion, closure requirements, Reynolds stress,

dissipation rate. Isotropic turbulence, homogeneous shear flows, free shear flows, wall bounded flows. Scalar transport, particulate transport

Advanced Aerodynamics (3-0)

Two- and three-dimensional potential flow about wings and bodies; Unsteady aerodynamics, slender-body theory, Viscous effects, airfoil stall, high-lift systems, boundary-layer control, Wings and bodies at transonic and supersonic speeds, numerical methods

Advanced Aerothermodynamics (3-0)

Aerothermodynamics of Aerospace vehicles, (missiles, space planes, air-breathers), flight dynamics (trajectory, range, stability), aerothermodynamics (fluid dynamics, thermodynamics, aerodynamics, heating) and propulsion systems (scramjets, combined cycles)

Advanced Heat Transfer (3-0)

Different modes of heat transfer, i.e. Conduction, Convection and Radiation 2-D steady and 1-D unsteady problems in conduction, Forced and free convection and the equations of motion, energy and mass conservation

Advanced Combustion (3-0)

Fundamentals of combustion systems, fire and explosion phenomena, Thermochemistry, chemical kinetics, laminar flame propagation, detonations and

explosions, flammability and ignition, spray combustion and the use of computer techniques in combustion problems, Thermodynamics of gas mixtures, chemical kinetics, conservation equations for multi-component reacting gas mixtures, deflagration and detonation waves. Nozzle flows and boundary layers with reaction and diffusion



Rocket Propulsion (3-0)

Analysis of liquid and solid propellant rocket power plants, propellant thermo chemistry, heat transfer, system considerations. Low-thrust rockets, multi-stage rockets, trajectories in powered flight, electric propulsion, Space Propulsion and Power Systems, Analysis and performance of chemical and nuclear rockets, electric propulsion systems, Introduction to solar, chemical, thermoelectric and nuclear power sources, Aerothermochemistry of Advanced Propulsion Systems, Physics and chemistry needed to analyze high performance rocket propulsion systems including reacting high temperature radiating gas and plasma flows

Mechanical Behavior of Materials (3-0)

Types of stresses and strains, elastic and plastic deformation, defects and imperfections in single and polycrystalline materials, classification of defects, tensile, compression, torsion, bend, impact and fracture, toughness testing of materials. Effect of strain rate on flow properties of materials, fracture mechanics, fatigue, creep and stress rupture of materials, Griffith and Orwan theory of fracture of materials, factors affecting fatigue, stress rupture test, Nabarro-Herring and Coble creep, embrittlement and its types, materials' selection and failure analysis, case studies

Finite Element Methods (3-0)

Introduction to Finite Element Method (FEM), mathematics preliminaries, truss analysis, variational and weighted residual formulations, general approach to structural analysis, on continuous shape function, stress analysis for one & two-dimensional problems of structures, beam analysis, and ANSYS software for FEA analysis

Aerospace Structural Analysis (3-0)

Stress analysis of elastic structures for aerospace application under different loading conditions, Shear flow distribution in thin-wall structures, Bending and torsion analysis of thin walled structure, Buckling of thin plates, columns, shear panels,

compression panels and thin walled circular and conical cylinder

Mechanics of Composite Structures (3-0)

Composite material and their constituents, Unidirectional composites behavior of laminated composite plates under various loading conditions, classical lamination theory, effective stiffness properties of composites, Constitutive description of laminated plates, Laminated plate theory, Edge effects in laminates, Governing Differential Equations for various conditions, Laminated plates with moderately large deflections, Failure theories and experimental results for laminates.

Aero Elasticity Theory (3-0)

Composite material and their constituents, Unidirectional composites behavior of laminated composite plates under various loading conditions, classical lamination theory, effective stiffness properties of composites, Constitutive description of laminated plates, Laminated plate theory, Edge effects in laminates, Nonlinear theory of generally laminated plates, Governing equations in the Von Karman sense, Laminated plates with moderately large deflections, Post buckling and nonlinear vibration of laminated plates, Failure theories and experimental results for laminates

Advanced Structural Dynamics (3-0)

Free and forced vibration of single-degree-of-freedom, two-degree-of-freedom and multiple-degree-of-freedom, determination of natural frequencies and mode shapes, continuous systems, vibration control



Aero Elasticity Theory (3-0)

Equations of the theory of elasticity in different co-ordinate system, solution to plane stress and plane strain problems, Fourier transformation method and St. Venant's principle, Solution to plates of various profiles and end conditions along with the most commonly used numerical energy methods

Theory of Plasticity (3-0)

Foundations of plasticity, elastoplastic bending and torsion, plastic analysis of beams and frames, further solutions of elastoplastic problems, theory of the Slipline field, steady problems in plane strain

Fracture Mechanics (3-0)

Fundamental concepts, elastic-plastic fracture mechanics, dynamic and time-dependent fracture, fracture mechanisms in metals and nonmetals, fracture toughness testing of metals, fracture testing on nonmetals, fatigue crack propagation, environmentally assisted cracking in metals, computational fracture mechanics

Advanced Mechanics of Materials (3-0)

Elasticity, shear center and unsymmetrical bending, curved flexible members and stresses in flat plates, torsion of non-circular sections, stresses in rotary sections and contact stresses

Theory of Elasticity (3-0)

Basic definitions of strain and stress tensors, derive strain-deformation relationships for finite and small deformations, derive compatibility conditions for strain tensors, equilibrium equations and formulate constitutive properties of orthotropic and isotropic elastic materials. Introduce the Airy stress functions for 2-D plane stress and plane strain problems in Cartesian and Cylindrical coordinate systems

Mathematical Modeling and Simulation (3-0)

Introduction to a Dynamic systems and control, modeling and analysis techniques, the fundamentals and applications of control systems, transfer functions, sensitivity and robust control and digital control. Case studies related to motion control system design, electromechanical system design, vehicle

suspension design and aircraft response modes

Experimental Stress Analysis (2-1)

Elementary elasticity and fracture mechanics, strain-measurement methods and related instrumentation, optical methods of stress analysis, coating methods and application of statistics

Experimental Methods in Structural Dynamics (2-1)

Vibration analysis Overview, experimental methods in vibration analysis, vibration measuring instruments, selection of sensors, accelerometer mountings, vibration excitors-mechanical, hydraulic, electromagnetic and electro-dynamics, frequency measuring instruments, system identification from frequency response, testing for resonance and mode shapes

Smart Structures (3-0)

Analysis, design and implementation of smart structures and systems, modeling of beams and plates with induced strain actuation, shape memory alloys, electro-rheological fluids, magnetostrictor and electrostrictor actuators and fiber optic sensors

Optimization Techniques in Structural Design (3-0)

Unconstrained and constrained optimization techniques, advanced optimization techniques, static and dynamic applications

Nonlinear Dynamics and Chaos (3-0)

Modeling of Duffing-type Mathieu systems, sources of geometrical and material non-linearity, non-dimensionalisation of equation of motion, methods of harmonic balance and simple perturbation, review of Floquet theory, basics of stability analysis, chaotic dynamics, how to identify chaotic vibrations, point attractors and limit cycles in autonomous systems, periodic and chaotic attractors, bifurcations and Lyapunov exponent, applications in the physical sciences



Modern Control Theory (3-0)

Applications of modern control theory to flight control, Controller design based on optimal control techniques. Nonlinear system theory applications, typical aerospace control methods such as model following, load alleviation, and flutter suppression, recent advances in aerospace vehicle control

Guidance and Navigation of Aerospace Vehicles (3-0)

Principles of guidance systems for spacecraft, launch vehicles, homing and ballistic missiles. Optimal guidance, Interplanetary transfer guidance with low thrust, Principles of inertial navigation, theory and applications of the Global Positioning System, Celestial navigation procedures, application of Kalman filtering to recursive navigation theory

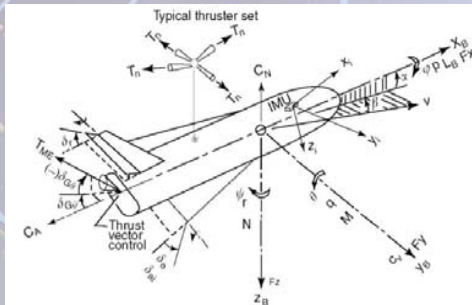
**Automatic Control of Flight Vehicles (3-0)**

Application of classical and modern linear control theory to automatic control of flight vehicles. Spacecraft attitude control, control of flexible vehicles, Linear-quadratic regulator and pole-placement design applications

**Orbital Mechanics (3-0)**

Review of 2-body problem, Orbit perturbation analysis, Gravity field expansions and effects on orbiters, 3-body problem with applications

Methods of Optimization (3-0)

Applications of unconstrained and constrained parameter optimization, dynamic programming and optimal control theory to problems in aerodynamics, aerospace structures, flight dynamics and control and aerospace design, numerical methods of optimization

Systems Engineering and Analysis (3-0)

Introduction to organized multidisciplinary approach to designing and developing systems, Concepts, principles and practice of systems engineering as applied to large integrated systems, Life-cycle costing, scheduling, risk management, functional analysis, conceptual and detail design, test evaluation and systems engineering planning and organization

Aerospace System Design and Management (3-0)

The course will offer a comprehensive introduction to modern design and management methods. The course will concentrate on successful management examples of complex aerospace projects

Reliability Engineering (3-0)

Introduction to reliability engineering, basic concepts from statistics, the quantification of reliability and its related functions, analysis of reliability data, load-strength, interference, reliability in design and testing

Computer Aided Design (3-0)

Computer generation of geometric models, calculation of design parameters, trade-off diagrams and finite-element modeling and analysis

Thesis (0-6)

Thesis will be given after scoring min. 3.00 CGPA in 24 credit hours. Individual project based work carried out under the supervision of one or more members of academia. Each project requires background reading, investigation, analysis, experimentation and/or development, testing, data gathering, data analysis and evaluation of results. The balance between the various aspects will vary from project to project but all should include experimentation, numerical analysis or innovative data processing and critical analysis of the results

PhD in Aerospace Engineering

Eligibility Criteria

- MS/ M.Phil/ equivalent (18 Years of education) with a strong background in relevant discipline preferably Aerospace, Avionics, Electrical, Electronics, and Mechanical Engineering with minimum CGPA 3.00 out of 4.00 or First Division (where CGPA not available) from HEC/PEC recognized Institute/University or from Foreign Institute/University of good repute
- Valid GAT-A (General - Engineering Category) conducted by NTS with $\geq 60\%$ score or Valid HAT-I (Engineering Category) administered by the Education Testing Council (ETC-HEC) with $\geq 60\%$ score or GRE International (General) conducted by ETS, USA, with minimum score as Quantitative: 145, Verbal: 145, Analytical: 3.5 or Valid GAT (Subject) conducted by NTS in the relevant field of study with $\geq 60\%$ score or Minimum 60% marks in test equivalent to GRE/ HAT General/ Subject conducted by the Higher Education Institution (HEI). The IST institutional code to receive GRE scores is 1758.

Course work

- Minimum 24 credit hours of course work must be undertaken with at least CGPA of 3.0 out of band 4.0 if the student has a prior MS degree in the same specialization otherwise he/she may have to study extra courses up to 16 in total (48 credit hours in total)
- A student enrolled in the PhD program on a BS degree will have to study 48 credit hours in total
- Migration/ Transfer of the courses from other Universities/ Institutes is allowed as per IST Migration/ Transfer policy
- The list of eight PhD courses must have been approved by DBGS
- The DBGS will also assign student a supervisor as per IST Policy in vogue after conduct of presentation
- PhD students may have to do extra course work as per HEC latest PhD policy

Comprehensive Examination

Comprehensive examination is conducted after successful completion of PhD course work. Student will be required to appear in comprehensive exam within 6 months after completion of course work. Schedule and structure of this exam will be as per IST policy. Students, who fails in comprehensive exam, will be allowed only once to reappear, failing which, the PhD-studentship will be terminated from IST

Research Proposal

After successfully passing comprehensive exam, a student will write research proposal and present/defend proposal in front of DBGS. The presentation/defense of proposal will be accepted or rejected by DBGS



Research Work

- 24 credit hours of research work spanning over at least two years through continuous registration in Thesis-I, Thesis-II, Thesis-III, and Thesis-IV of 6 credits each
- At least one research publications in journal(s) of W-category (Preferably), defined by HEC, and these publications should also be ranked by HJRS, defined by IST. The publications topic(s) should be relevant to the PhD specialization area of research.

*Committee comprises of one internal (field experts in the department other than supervisor) and at least one external examiners (field experts from many other HEC recognized Institute).

PhD Thesis

On the successful completion of research work, the student will write a detailed report/ thesis about research outcome. This thesis/ report will then be recommended by DGBS. Moreover, A plagiarism check will also be and endorsed by the respective supervisor as per HEC policy. After getting a clearance certificate, this thesis will be sent to the international reviewer of technologically advanced countries (see guidelines of HEC for the advance countries list) and national expert of the relevant research area. An open defense of the thesis after positive feedback from foreign and national expert will be arranged. This defense will be conducted in the presence of defense committee and general audience. A viva meeting between candidate and defense

committee to discuss corrections required in the dissertation will be held and the candidate will be informed about the outcome of defense

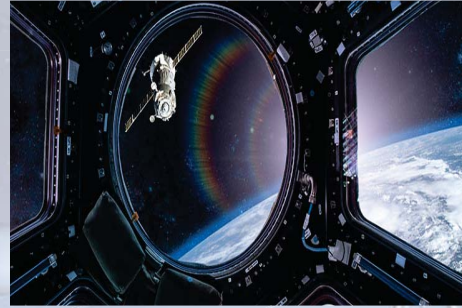

Award of PhD Degree

A PhD degree will be awarded to the students after completion the following requirements

- Successful completion of course work (18 credit hours)
- Successful completion of



- comprehensive exam
- Successful presentation/ defense of synopsis
- Two research publications in JQRS indexed journals
- At least two evaluations by the experts from technologically advanced countries, defined by HEC (Foreign experts)
- Evaluation of thesis by at least two local experts (National universities experts)
- Successfully defending the thesis in front of Defense Committee Approval by Graduate Studies & Research Council (GSRC)
- Changes in the IST-PhD policy can be made at any time as per HEC recommendations

*Committee comprises of one internal (field experts in the department other than supervisor) and two external examiners (field experts from any other HEC recognized Institute).



Note: Changes in PhD policy can be made to keep it in compliance with HEC guidelines and rules & regulations. These can be issued without any prior notice and shall be applicable to all students instantly.

Electrical Engineering



The Department of Electrical Engineering (EE) runs an internationally recognized academic programs in Electrical Engineering and Computer Science. The program in Electrical Engineering offers specializations in Wireless Communications, Signal and Image Processing, RF & Microwave and Electronics & Embedded Systems and the

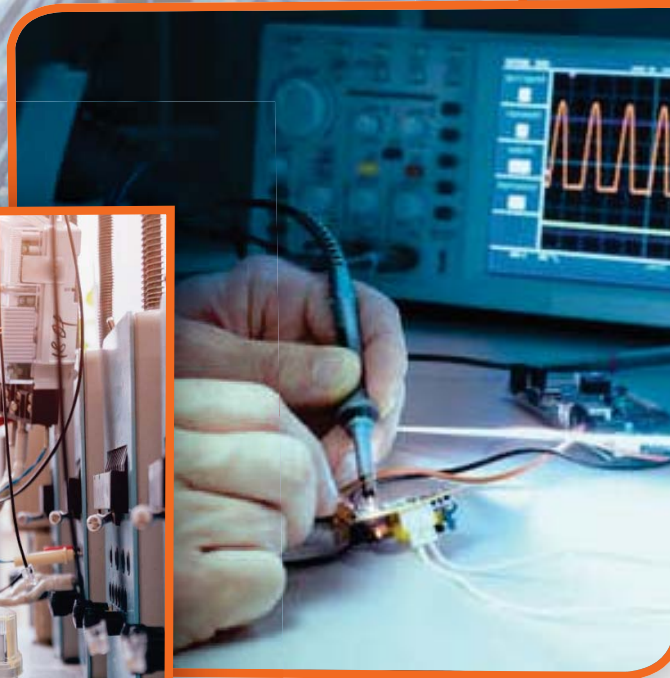

program in Computer Science offers focused areas in Artificial Intelligence & Computer Vision and Cyber & Information Security. The department consists of experienced faculty, well-equipped classrooms and state-of-the-art lab facilities. The department provides continuous academic improvement through consultation with faculty, industry, engineering & computing professionals, and students. The focus of the programs is on the

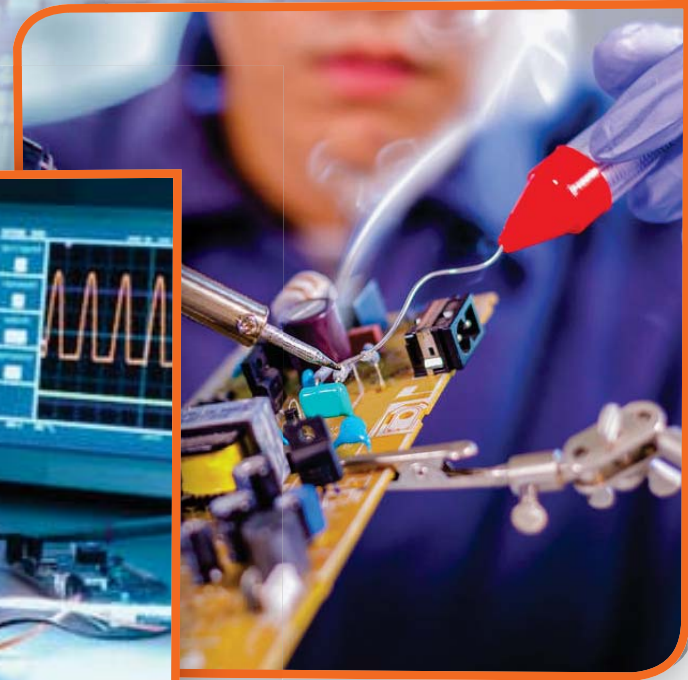

design, analysis, development and testing of engineering systems, encompassing network and physical layer aspects of wired and wireless systems, Satellite subsystems, Radio Frequency front end, along with in depth knowledge of associated signal and image processing techniques, artificial intelligence, and cyber & information security. The curriculums are designed to provide students with the necessary depth in their chosen area of specialization as well as the necessary breadth to be able to understand complete systems.

Mission Statement

Mission of the department is to offer an open and thinking environment that spurs: interest in research; emphasizes teaching excellence; meet the educational and personal needs of students; incorporate collaborative research with other universities and relevant industry; effective teaching; academic advising; counseling; and through university- sponsored cultural, recreational, and extracurricular programs.

Program Educational Objectives

- Coordinate the electrical engineering program's educational objectives, and learning outcomes with the objectives of National Telecommunication Policy, National Space Policy and vision of the President of Pakistan
- To produce engineers who can develop engineering solutions that are well-conceived and carefully implemented to meet public and private sector needs
- To produce graduate engineers who would be thoroughly equipped with necessary tools and skills set to carry out research in pursuit of developing cost effective and innovative solutions
- To produce graduate engineers who will contribute effectively by solving complex engineering problems, as leader and/or team members

- To act responsibly within society in light of the obligations that engineers have to design and develop effective products that are of positive value to the society, and will practice leadership in advising society on the wisdom of specific developments, and will act with honesty and integrity, with courage and compassion
- To practice professional ethics under all circumstances
- To foster personal and organizational success in a dynamic, globalized professional environment. Driven to continuous lifelong learning by an inherent desire of discovery and societal improvement

Research Projects

The department is actively involved in research projects related to wireless communications, signal and image processing and RF and Microwave. This is evident by the department receiving over 150 million in research funding from HEC and ICT R&D fund since 2015. Some of the current/ recent projects conducted by the faculty include

Wireless Communications

- Implementation of a 5G research test bed (funded by HEC)
- Cellular communication using High Altitude Platform (funded by ICTRD)
- Physical and cross layer aspects of future 5G wireless networks

- Internet of things for 5G Networks
- Efficient spectrum sensing in cognitive radios

Signal and Image Processing

- Content based Information retrieval from Urdu document images using word document (funded by HEC)
- Implementation of a radar test bed (funded by HEC)
- Image based retrieval of brain states at rest
- Frequency dependencies of dynamics in functional networks of the brain

RF & Microwave

- K-band RF front end development for SDR
- High gain deployable antennas for small satellites particularly CubeSat
- Low cost RF components for small satellites
- RF front end for SAR and UWB radars

Satellite

- Design, development and integration of 3-U CubeSat (funded by HEC)
- Design, development and integration of 3-U CubeSat (funded by APSCO)
- Design, development of Micro-Satellites

Prerequisites

- BS/ BE/ equivalent (16 Years of education) with strong background in Electrical, Electronics, Telecommunications, Communications Systems, Computer Engineering, Avionics Engineering or Other subject to approval by the department with minimum CGPA ≥ 2.00 out of 4.00 or $\geq 60\%$ marks (where CGPA not available) from HEC and PEC recognized (where applicable) Institute/University or from Foreign Institute/University of good repute
 - GAT-A (General) conducted by NTS in the relevant field of study with $\geq 50\%$ marks or HAT (General) conducted by HEC in the relevant field of study with $\geq 50\%$ marks or GRE International (General) conducted by ETS, USA, with minimum score as Quantitative: 145, Verbal: 145, Analytical: 3.5
- The IST institutional code to receive GRE scores is 1758

Degree Plan*

For degree completion, students are required to complete 24 credit hours of course work and 6 credit hours of thesis/ research.

At the end of 1st semester, students will be required to select one of the following specializations:

- Wireless Communication (WC)
- Signal & Image Processing (SIP)
- RF & Microwave (RF&M)
- Electronics & Embedded Systems (E&ES)
- Satellite Systems (SS)

Mandatory courses and thesis topics will depend on the selected areas of specialization.

Semester	Courses	Cr. Hr.
01	Advanced Engineering Mathematics	03
	Advanced Electronics	03
	Advanced Digital Signal Processing	03
02	Mandatory course I	03
	Mandatory course II	03
	Elective I	03
03	Mandatory course III	03
	Elective II	03
	Thesis I	03
04	Thesis II	03

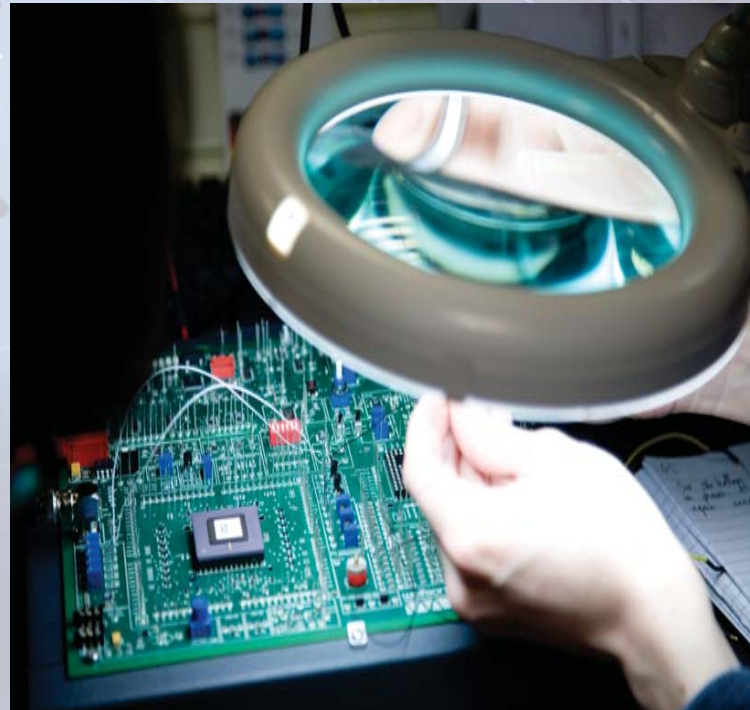

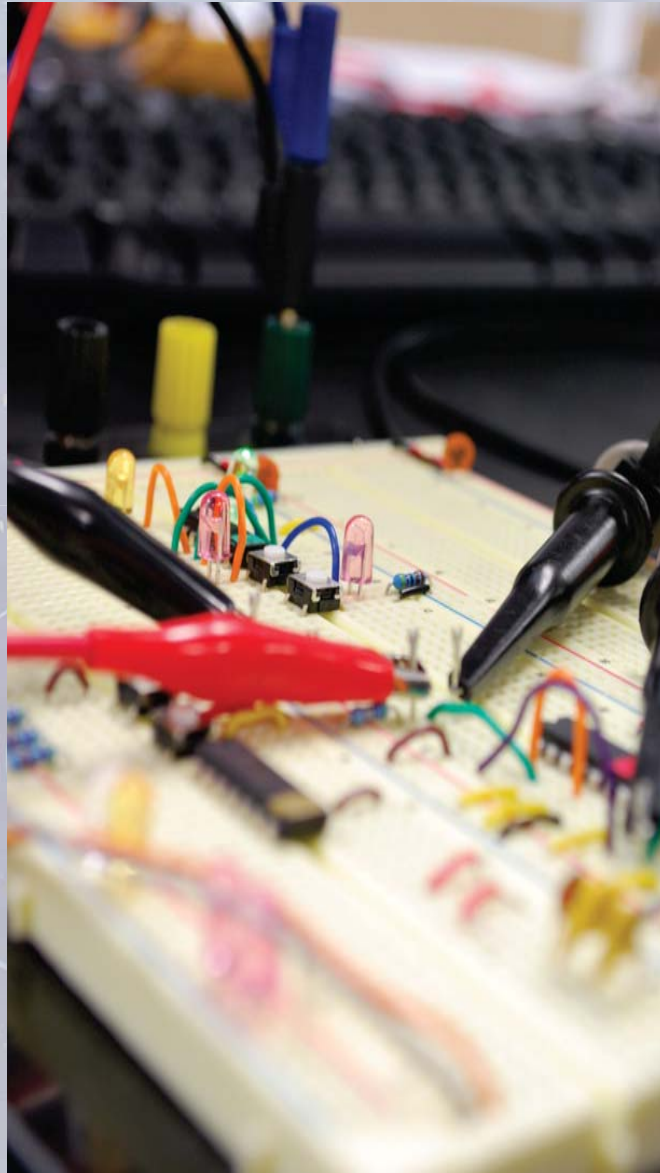

MS Electrical Engineering with specialization in Wireless Communications

Semester	Mandatory Courses	Cr. Hr.
02	Advanced Digital Communication	03
	Advanced Wireless Communication	03
03	Advanced Satellite Communication	03

Students in this specialization typically choose thesis topics from following applications areas:

- Point to Point communication
- Wireless Communications
- Multi-relay network

MS Electrical Engineering with specialization in Signal & Image Processing

Semester	Mandatory Courses	Cr. Hr.
02	Pattern Recognition	03
	Advanced Digital Image Processing	03
03	Computer Vision & 3D	03

Students in this specialization typically choose thesis topics from following applications areas:

- Image and Video Analysis
- Acoustic/ speech Signal Processing
- Medical Signal Processing
- Hyperspectral Image Analysis

*Please note that the ordering of the mandatory courses in the proposed degree plan might change depending on the faculty availability

MS Electrical Engineering with specialization in RF & Microwave

Semester	Mandatory Courses	Cr. Hr.
02	Advanced Electromagnetic Field Theory	03
	RF Circuit Design and Analysis	03
03	Antenna/Antenna Array Theory and Design	03

Students in this specialization typically choose thesis topics from following applications areas:

- Antenna Design
- RF front end development
- Microwave circuits

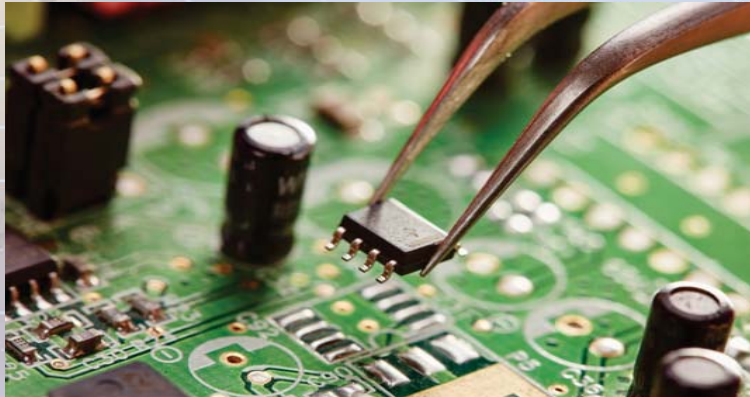

MS Electrical Engineering with specialization in Electronics and Embedded Systems

Semester	Mandatory Courses	Cr. Hr.
02	Electronics for Space Applications	03
	Advanced Embedded Systems	03
03	Advanced Power Electronics	03

Students in this specialization typically choose thesis topics from following applications areas:

- Electronic Systems Design Techniques
- Applications of Embedded Systems
- Satellite System Design

MS Electrical Engineering with specialization in Satellite Systems

Semester	Mandatory Courses	Cr. Hr.
02	Electronics for Space Applications	03
	Spacecraft System Design	03
03	Satellite Communication	03

Elective Courses

Depending on interest, students can select mandatory courses of other specializations as their electives. Other electives can also be offered to students. A tentative list of other possible elective courses is below:

- Signal Estimation & Detection Theory
- Information Theory
- Methods of Optimization
- Machine Learning
- Operations Research
- Spacecrafts System Design
- Low Power Design
- Advanced Microprocessor and Memory Design
- Advanced Computer Architecture
- Advanced Analog Design



Course Description

708608 Satellite

Communications/A

Introduction to Satellite Systems, Satellite Systems Planning, Satellite Organizations and state-of-the-art review, Regulation of the spectrum, Satellite Systems Business. Orbital Mechanics (Satellite Orbits, Earth-Satellite Geometry, Coordinate Systems, Coverage area. Slant range. Azimuth and Elevation Angles, Orbital Perturbations, Station Keeping, Launcher Systems). Spacecraft Environment. Overview of Satellite Subsystems and details of Communication Subsystem and Telemetry Tracking Command & Control Subsystem. The RF link Equation, Power flux density, Equivalent isotropic radiated power (EIRP), Noise temperature, C/No. Eb/No. G/T, Free space loss, Decibel (dB) notation. Uplink, downlink and composite performance. Intermodulation products, Backoff, Polarization, Rain Loss and Atmospheric Effects, Modulation and Coding Schemes, Transponder (Transparent, Regenerative and on-board processing Transponders). Ground Station Technology. Advanced Multiple Access Schemes

EE-764 Spacecraft Systems Design

Geocentric Orbits & Orbital Maneuvers, Basic Orbits, Real Orbits, Orbital Manoeuvres. Attitude Dynamics & Attitude Control Systems,

Rigid Body Dynamics, Attitude control Systems, Attitude Determination, Getting to Orbit, Propulsion Technology, Launch Vehicles



708604 Advanced Digital Communications

Introduction to source coding, Quantization, Prediction, Redundancy removals, Time and frequency domain speech coding, Transform coding of Image/video, Entropy coding of image/video, Standards, Future Research area, Error Control Coding: Introduction, Implementation, Convolutional codes, Simple Linear block Codes, Serial Concatenation, Modulation: Introduction to digital modulations, Phase Shift Keying, FSK, Bandwidth-efficient modulations, Spectrally controlled modulation

708606 Advanced Wireless Communications

Wireless Channel Models, Performance of Wireless Channels, Noise and Interference, Pathloss and Shadowing, Equalization, Diversity

and Space-Time Coding, Diversity Multiplexing Tradeoffs, Wireless Networks and Resource Management, Wireless Networks for fixed mobile systems, MIMO, Digital Modulation over Wireless Channels

708506 Advanced Digital Signal Processing

Discrete Time Signals And Systems, Linear, Time Invariance, Causality, Stability, Properties of LTI Systems, Linear Constant Coefficient Difference Equations, Eigen Functions For LTI Systems, Fourier Transform Theorems, The Z-transform, Region Of Convergence, Inverse Z-transform, Z-transform Properties, Sampling, Multi-rate Signal Processing, Quantization Errors, Transform Analysis of LTI Systems, Minimum Phase Systems, Generalized Linear Phase, Structures For Discrete Time Systems, Filter Design, DFT, Computation of DFT, FFT Algorithm, Decimation In Time & Decimation In Frequency FFT, The Chirp Transform Algorithm, Homomorphic Signal Processing, Discrete Hilbert Transform



708507 Advanced Digital Image Processing

Image analysis, Preprocessing, Image enhancement, Discrete transforms, Fourier analysis, discrete cosine, filtering, wavelet analysis, Freq. filters, Morphological image processing, point, line and edge detection, geometric transforms, image compression: system model, lossy and lossless methods

708508 Pattern Recognitions

Introduction to Pattern Recognition, Features, Statistical Decision Methods, Bayesian Decision Theory, Structural and Hybrid Methods, Principal Component Analysis (PCA) and Linear Discriminant Analysis (LDA), Hidden Markov Models, String matching algorithms, Dynamic Time Warping, Linear Discriminant Functions, Support Vector Machines

708423 Computer Vision and 3D

Color image processing, multi-sensor images, and extraction of structural features from images, recognition methods for computer vision, 3D modeling, stereoscopy, 3D image reconstruction, Video Analysis and compression

623205 Advanced Engineering Mathematics

Metric spaces and normed vector spaces; Norms and normed vector spaces. Orthogonal spaces and orthogonalization; Hilbert and Banach spaces, Basis sets for

subspaces. Complements of sets and spaces. Linear mappings. The four subspaces of the linear transforms, Approximation in Hilbert spaces Normal equations, positive definiteness, Gramian. Principle of orthogonality. Matrix formulation of the least squares problem. Best linear unbiased estimate; Applications, Continuous and discrete polynomial approximation. Linear regression. Least squares filtering and estimation. Prediction and function fitting. Minimum mean square estimation; Applications, Right inverse and left inverse. Full row rank and full column rank. Least squares solutions, minimum norm solution. Matrix rank and invertibility. Rank in numerical analysis, LU factorization, Cholesky, Unitary matrices and QR decomposition. Householder and Givens transformations, Eigenvectors, diagonalization and linear systems. Subspaces and invariance. The geometry of eigenvectors; Applications, The SVD theorem; SVD properties; System identification using SVD; Total least squares, Modal matrices; Permutation matrices; Toeplitz matrices and Circulant matrices; Vandermonde matrices, Newton's method and steepest descent; Conjugate gradient; Applications, Convexity, Theory of constrained optimization; Lagrange multipliers; Inequality constraints: Kuhn-Tucker conditions; Introduction to linear programming

608704 Advanced Electromagnetic Field Theory

Basic Electromagnetic Field Theory and finishes at discussing different applications of EMF such as Antennas, Wave Propagation, Microwaves and EMC / EMI. The course will go in detail to explain the Maxwell equations and their use in solving different electromagnetic field problems

708707 RF Circuit Design and Analysis

Design of different microwave / RF components such as couplers, power dividers / combiners / isolators / mixers / oscillators. The course will also cover in great detail the concepts of microwave network analysis, impedance matching and etc. The course will also cover microwave resonators and filters

608705 Antennas and Arrays Theory and Design

Basic concepts of Antennas starting from the radiation concepts to the fundamental parameters. The course will introduce the basic antenna



elements and then will put great emphasis on the design of antenna arrays

7xxxx Embedded System Design

Embedded systems: Definition, classification and examples, Design metrics (costs, performance, time to market), Anatomy of an embedded system and summary of course topics, Processor peripherals: General introduction to embedded processors and their peripherals, Internal structure of specific microcontroller (Microchip PIC18 or Texas Instrument MSP430), address decoders, configuration registers, pipelining, Microprocessor interfacing: polling, interrupt, DMA, Reminders on Timers and counters, Reminders on A/D and D/A conversion systems, sampling, aliasing, quantization, errors, ENOB, Interfacing of ADC and DAC with the microcontrollers, Sensor and Signal conditioning, Communication: Reminders on serial and parallel protocols, delays, skew, Synchronous transmission and clock data recovery, Communication protocols: UART, SPI, CAN, USB, Interconnection and signal integrity problems, Memories: Memory hierarchies and caches, ROM, OTPROM, EPROM, EEPROM, Flash, Static and dynamic RAMs, Memory composition and microprocessor interfacing

Electronics for Space Applications

Introduction to space and spacecraft, classification of satellites and satellites missions, space environment, space environment and Orbital Mechanics, Electrical Power Subsystem, Propulsion System, Telemetry, Tele-command and Communication Subsystem, Thermomechanical Subsystem, Satellite Electronics, Spacecraft Testing and QAPA, Radiation effect and mitigation, Command & Data Handling Subsystem

Advanced Power Electronics

Introduction of Power Electronics, DC-DC Converters, Principles of Steady State Converter Analysis, Steady State Losses and Efficiency, Switch Realization, The Discontinuous Conduction Mode, Converter Circuits, Converter Transfer Functions



PhD in Electrical Engineering Eligibility Criteria

- MS/ M.Phil/ equivalent (18 Years of education) with a strong background in relevant discipline with minimum CGPA 3.00 out of 4.00 or First Division (where CGPA not available) from HEC/PEC recognized Institute/University or from Foreign Institute/University of good repute
- Valid GAT-A (General - Engineering Category) conducted by NTS with $\geq 60\%$ score or Valid HAT-I (Engineering Category) administered by the Education Testing Council (ETC-HEC) with $\geq 60\%$ score or GRE International (General) conducted by ETS, USA, with minimum score as Quantitative: 145, Verbal: 145, Analytical: 3.5 or Valid GAT (Subject) conducted by NTS in the relevant field of study with $\geq 60\%$ score or Minimum 60% marks in test equivalent to GRE/ HAT General/ Subject conducted by the Higher Education Institution (HEI). The IST institutional code to receive GRE scores is 1758.

Research Prerequisites

- Research proposal (intended research work during PhD) approved by Departmental Board of Graduate studies

(DBGS)*

- A PhD candidate will be required to give a presentation to DBGS related to his/her research proposal before his/her research is finalized

Course work

Minimum 18 credit hours of course work must be undertaken with at least CGPA of 3.0 out of band 4.0 Migration/ Transfer of the courses from other Universities/ Institutes is allowed as per IST Migration/ Transfer policy. The list of six PhD courses must have been approved by DBGS. The DBGS will also assign him/her a supervisor as per IST Policy in vogue after listening to his/her presentation

Comprehensive Examination

Comprehensive examination is conducted after successful completion of PhD course work. Student will be required to appear in comprehensive exam within year after completion of course work. Schedule and structure of this exam will be as per IST policy. Students, who fail in comprehensive exam, will be allowed only once to reappear, failing which, the PhD studentship will be terminated from IST

Synopsis

After successful passing of the comprehensive exam, a student will write his/ her synopsis paper and present/ defend his/ her synopsis in front of DBGS. The presentation/

defense of synopsis will be graded by DBGS, written Synopsis is 40% and presentation is 60%. The passing marks of synopsis are 60%

Research Work

24 credit hours of research work spanning over at least two years through continuous registration in Thesis-I, Thesis-II, Thesis-III, and Thesis-IV of 6 credits each. Two research publications in journal(s) of W-category, defined by HEC, and these publications should also be ranked by Journal Quality Ranking System (JQRS) (<http://jqrs.ist.edu.pk>), defined by IST. It is important to mention that only W-category journals of HEC are ranked in JQRS. The publications topic(s) should be relevant to the PhD specialization area of research

PhD Thesis

On the successful completion of research work. The student will write a detailed report/ thesis about his/ her research outcome. This thesis/ report will then be recommended by DGBS. Moreover, A plagiarism check will also be conducted and endorsed by the respective supervisor as per HEC policy. After getting a clearance certificate, this thesis will be sent to the international reviewer of technologically advanced countries (see guidelines of HEC for the advance countries list) and national expert of the relevant research area. An open defense of the thesis after positive feedback from foreign and national expert will be arranged. This

defense will be conducted in the presence of defense committee and general audience. A viva meeting between candidate and defense committee to discuss corrections required in the dissertation. The candidate will be informed about the outcome of defense.

Award of PhD Degree

A PhD degree will be awarded to the students after completion the following requirements

- Successful completion of course work (18 credit hours)

- Successful completion of comprehensive examination
- Successful presentation/ defense of Synopsis
- Two research publications in JQRS indexed journals
- At least two evaluations by the experts from technologically advanced countries, defined by HEC (Foreign experts)
- Changes in the IST-PhD policy can be made at any time as per HEC recommendations

*Committee comprises of one internal (field experts in the department other than supervisor) and two external examiners (field experts from any other HEC recognized Institute).



Note: Changes in PhD policy can be made to keep it in compliance with HEC guidelines and rules & regulations. These can be issued without any prior notice and shall be applicable to all students instantly.

Computer Science

Prerequisites

- BS/ BE/ M.Sc./ equivalent (16 Years of education) preferably in one of the below mentioned field of studies with minimum CGPA = 2.00 out of 4.00 or = 60% marks (where CGPA not available) from HEC and PEC/ NCEAC (where applicable) recognized Institute/ University or from Foreign Institute/ University of good repute
 - Electrical/ Electronics/ Communication/ Telecommunication/ Computer/ Aerospace / Avionics / Aeronautical/ Mechatronics/ Mechanical/ Software Engineering or
 - BS Communication Systems/ Computer Science/ Information Technology or
 - MSc Communication Systems/ Computer Science/ Information Technology
- GAT-A and GAT-C (General) conducted by NTS in the relevant field of study with $\geq 50\%$ marks or HAT (General) conducted by HEC in the relevant field of study with $\geq 50\%$ marks or GRE International (General) conducted by ETS, USA, with minimum score as Quantitative: 145, Verbal: 145, Analytical: 3.5

The IST institutional code to receive GRE scores is 1758

Degree Plan

For degree completion, students are required to complete 24 credit hours of course work and 6 credit hours of thesis/ research.

Elective Courses

- Pattern Recognition
- Advanced Image Processing
- Deep Learning
- Applied Cryptography
- Advanced Network Security

- Computer Forensics /Digital Forensics
- Mobile Communications & Networking
- Distributed Networking
- Network Management
- Advanced Information Theory
- Computer Vision & 3D
- Text mining
- Advanced Data Mining
- Advanced Database Management Systems
- Advanced Human Computer Interaction
- Advanced Neural Networks and Fuzzy Logic
- Network Performance Evaluation
- Network Protocols and Standards
- Advanced Artificial Intelligence
- Advanced Data Warehousing
- Software Quality Assurance
- Wireless Sensor Networks
- Big Data Analytics

Semester	Courses	Cr. Hr.
01	Theory of Programming Languages	03
	Advanced Analysis of Algorithms	03
	Advanced Operating Systems	03
02	Advanced Computer Architecture	03
	Elective I	03
	Elective II	03
	Research Methods*	03
03	Elective III	03
	Elective IV	03
	Thesis I	03
04	Thesis II	03

*Noncredit course

Course Description

Theory of Programming Languages

Preliminaries, Evolution of the major programming languages, Describing Syntax and Semantics, Name, Bindings Type Checking and Scope, Data Types, Expressions and Assignment Statements, Statement-Level Control Structures, Subprograms, Implementing Subprograms, Abstract Data Types and Encapsulation Concepts, Support for Object-Oriented Programming, Concurrency, Exception Handling and Event Handling.

Advanced Analysis of Algorithms

Introduction, Underlying mathematical theory, Induction and recursion techniques in analyzing algorithms, Asymptotic notations, Search techniques, Divide-and-conquer technique, Randomized algorithms, Heuristic algorithms, Brute Force approach, Backtracking, branch-and-bound, Optimization techniques in algorithms designing, Dynamic algorithms, Greedy



algorithms, Graph Theory, Searching algorithms, Minimal spanning tree algorithms, Polynomials and FFT, Number theoretic notations, Number theoretic algorithms, RSA cryptosystems, String matching, pattern matching, NP completeness and NP completeness proofs.

Advanced Operating Systems

Kernel: interrupt handler, dispatcher, wait/signal, Kernels and Tracing, Getting Started with Kernel Tracing, Process Manager and Intercommunications: deadlocks, semaphores, concurrency, message passing, Memory Manager: segmentation, paging, shared memory, Drivers: I/O, buffering, spooling, File Structure: directory, storage, integrity, Scheduler: queuing theory, scheduling policy, shared resources, Protection: fault avoidance, error detection, error handling, error recovery, Performance Measurement, Tuning and Modeling

Advanced Computer Architecture

Asynchronous/synchronous computation/communication, concurrency control, fault tolerance, GPU architecture and programming, heterogeneity, interconnection topologies, load balancing, memory consistency model, memory hierarchies, Message passing interface (MPI), MIMD/SIMD, multithreaded programming, parallel algorithms & architectures, parallel I/O, performance analysis and tuning, power, programming models (data parallel, task parallel, process-centric,

shared/distributed memory), scalability and performance studies, scheduling, storage systems, synchronization, and tools (Cuda, Swift, Globus, Condor, Amazon AWS, OpenStack, Cilk, gdb, threads, MPICH, OpenMP, Hadoop, FUSE).

Advanced Image Processing

Color, Camera models, camera calibration, Advanced image pre-processing: Scale in image processing, Line detection, Corner detection, Maximally stable extremal regions, Mathematical Morphology: binary, gray-scale, skeletonization, granulometry, morphological segmentation, Image Compression: Texture, Image Registration: rigid, non-rigid, RANSAC

Pattern Recognition

Neural networks weights and activation functions, examples, matrix operations, Hopfield network structure, Neural networks training, feedforward backpropagation structure, Neural networks pruning definition and algorithms, detection of objects, unsupervised learning algorithms, k-nearest neighbor algorithm and code definition



Deep Learning

What is deep learning? DL successes; syllabus & course logistics, Gradient descent, logistic regression. Reading: Goodfellow, Probability, continuous and discrete distributions; maximum likelihood, cost functions, hypotheses and tasks; training data; maximum likelihood based cost, cross entropy, MSE cost; feed-forward networks; MLP, sigmoid units; neuroscience inspiration, learning via gradient descent; recursive chain rule (backpropagation); if time: bias-variance tradeoff, regularization; output units: linear, softmax; hidden units, Convolutional neural networks, probabilistic methods, Recurrent neural networks

Applied Cryptography

Computer Security Concepts, The OSI Security, Architecture, Security Attacks, Security Services, Security Mechanisms, A Model for Network Security, Symmetric Cipher Model, Substitution Techniques, Transposition Techniques, Rotor Machines, Steganography, Block Cipher Principles, The Data Encryption Standard (DES), A DES Example, The Strength of DES, Differential and Linear Cryptanalysis, Block Cipher Design Principles, The Origins AES, AES Structure, AES Round Functions, Key Management, AES Key Expansion, An AES Example, AES Implementation, Multiple Encryption and Triple DES, Electronic Codebook Mode, Cipher Block Chaining Mode, Cipher Feedback Mode, Output Feedback Mode, Principles of Public-Key Cryptosystems, The RSA Algorithm,

Diffie-Hellman Key Exchange, ElGamal Cryptosystem, Other IS Management Considerations-Implementing IS Management, Elliptic Curve Arithmetic, Elliptic Curve Cryptography, Pseudorandom Number Generation Based on an Asymmetric Cipher, Applications of Cryptographic Hash Functions, Two Simple Hash Functions, Requirements and Security, Symmetric Key Distribution Using Symmetric Encryption and Asymmetric Encryption, Distribution of Public Keys, X.509 Certificates, Public Key Infrastructure



Advanced Network Security

Taxonomy of network risks and security properties, Analyze and understand network security requirements to fulfill organizational requirements, Analyze operational and network security risks; protecting assets, threat and vulnerability modeling and assessment, Network attack vectors assessment and analysis, Identify and design the necessary network security controls to meet the organizational requirements and objectives, Cost-benefit analysis, Network and cyber security legislation and regulation, Network and cyber security standards including BSI ISO/IEC 27001:2013, IASME and ISF, Cyber Essentials

scheme, policies, processes and procedures, The design principles of a secure network architecture, Review the security evaluation criteria, Study and evaluate security frameworks and models, Departmentization and isolation, Virtual LANs (VLANs) and Private VLANs (PVLANS), Managing and maintaining secure operations and service delivery, Network security metrics, Identify and understand the identification, protection, detection, response and recovery, controls and mechanisms, Understanding how attack vectors exploit vulnerabilities in the network, Countermeasure principles, Firewall design and implementation principles, Unified Threat Management (UTM), IP Security (IPSec), SSL/TLS, secure web and email communications, Virtual Private Networks (VPNs), Securing network services and protocols. e.g. DNS, DHCP, SMTP and HTTP, Wired and wireless network security, The configuration of switches, routers and firewalls for network security, Mobile networking security, Switch and router security, Network access control (MAC, DAC and RBAC), authentication, authorization and accounting, Network privacy controls, Network anti-malware deployment and analysis, Intrusion



Detection System (IDS) and Intrusion Prevention Systems (IPS), Performance implications securing the network.

Computer Forensics / Digital Forensics

Forensics fundamentals and Investigation Processes: Data collection, Data Identification, searching, Data Acquisition and seizure, Data duplication/ data carving, Collecting digital evidence, Incident handling, Computer forensics tools, File systems and hard-disk Forensics: Hard drives, portable drives, CD, DVDs, Multi partitions, multi volume disks, server partitions, FAT /NTFS/ext2/ext3 file systems, Windows /Linux boot processes, Virtual machines, USB forensics, Registry Forensics, Steganography: Digital image Steganography, Steganalysis, Image file forensics, Audio file forensics, Network forensics: Analysis of network components logs, Investigation network traffics, Router forensics, Using Snort, Wire shark as network forensics tools, Investigating attacks, Investigating Internet crimes/web browsers forensics, investigation of Emails and email crimes, Web attacks, Dos attacks, Social Networking

Mobile Communications & Networking

Introduction and overview, Multiple access and cellular concept, Medium access control (MAC) protocols, Wireless LAN 802.11, Network architecture and mobility protocols,

Multimedia protocols, IoT Networking and Protocols, LTE networks, Security in mobile networks, Ad hoc networks, Economic, health, and social aspects

Distributed Networking

Introduction to Internetworking, protocol architectures, and data transport, Core Internet protocols, Introduction to routing and forwarding, Ethernet and other physical technologies, Limitations due to host machines, network, and mechanisms for distributed systems, Processes, memory models, portable code and middleware, Data security aspects, basic cryptology, and network security.

Network Management

Data Communications and Network Management Overview, Review of Computer Network Technology, Basic Foundations: Standards, Models, and Language, SNMPv1 Network Management: Organization and Information Models, SNMPv1 Network Management: Communication and Functional Models, SNMP Management: RMON, Network Management Tools and Systems, Network Management Applications, Web-Based Management.

Advanced Information Theory

Information measures, Self and Mutual information, Entropy, Markov Process, Huffman Coding, rate distortion theory, Gaussian Channels, multiple user source and channel theory, binary linear block codes, Hamming codes, Reed Muller codes, Galois fields, linear block codes over a finite field, cyclic

codes, implementation circuits, BCH and Reed Solomon codes, decoding algorithms, convolution codes and trellis based decoding, message passing decoding algorithms, trellis based soft decision decoding of block codes, trellis coded modulation.



Advanced Data Mining

Motivation for data mining, Data Preprocessing, Data mining primitives and query languages, Architectures of data mining systems, Major Data Mining Tasks, Cluster Analysis, Statistical measures in large databases, Classifications and Predictions, Anomaly Detection.

Advanced Database Management System

Theoretical concepts, Relational model conformity and Integrity, Advanced SQL programming, Query optimization, Concurrency control and Transaction management, Database performance tuning, Distributed relational systems and Data Replication, Object oriented, deductive, spatial, temporal and constraint database management systems, New database applications and architectures: e.g. Data Warehousing; Multimedia; Mobility; NoSQL, Native XML databases (NXD),

Document orientated databases, SQL standards development, Standards for interoperability and integration e.g. Web Services, Database security - Data Encryption, redaction and masking techniques. Authentication and authorization. Database auditing.

Advanced Human Computer Interaction

Introduction to HCI. Importance of usable and useful software products. The theories of HCI. How to evaluate/develop software products. How to apply theoretical results from HCI research to software products. How to conduct their own research about aspects of usability and user experience. Concepts of Human Computer Interaction. The psychology of usable things. Usability Engineering. Prototypes. Usability inspection methods. Usability testing methods. Usability in practice. User Experience (UX). Web Usability. Mobile Usability. Mobile User Experience. Site objectives and user needs. Information architecture. Information and navigation design. Implementation and optimization. Experiments and HCI guidelines. Current research topics in Human-Computer Interaction.

Artificial Neural Network and Fuzzy Logic

Concepts of Artificial Neural Networks, Kinds of Artificial Neural Networks, Multilayer Artificial Neural Networks, EBP Learning Algorithm, Recurrent Artificial Neural Networks, Artificial Neural Networks Applications, Concepts of Fuzzy Logic, Basic Elements of Fuzzy System, Universe of

Discourse and Fuzzy Sets Definitions, Fuzzy Production Rules and Fuzzy Algorithms, Fuzzy Applications,

Network Performance Evaluation

Overview of probability and stochastic processes used for the analysis of computer networks, Introduction to computer networks and network architectures, Delay models in data networks: Queueing models, Little's theorem, M/M/1 queue, M/M/m, M/M/∞, M/M/m/m and other Markov systems, M/G/1 queues, priority queueing, Networks of queues - Jackson's theorem, Medium access: Aloha systems: slotted and unslotted. Splitting algorithms, Carrier sensing, CSMA/CD, wireless LANs, Case Study: Software Defined Networks (SDN) and their performance.

Advanced Artificial Intelligence

Overview of Probability Theory, Bayes Networks, Independence, I-Maps, Undirected Graphical Models, Bayes Networks and Markov Networks, Local Models, Template Based Representations, Exact Inference: Variable Elimination, Clique Trees, Belief Propagation, Tree Construction, Intro to Optimization, Approximate Inference: Sampling, Markov Chains, MAP Inference, Inference in Temporal Models, Learning Graphical Models: Introduction, Parameter Estimation, Bayesian Networks and Shared Parameters, Structure Learning, Structure Search, Partially Observed Data, Gradient Descent, EM, Hidden Variables, Undirected Models, Undirected Structure Learning,

Causality, Utility Functions, Decision Problems, Expected Utility, Value of Information.

Software Quality Assurance

Introduction to Software Quality, Software Defects, Reasons of Poor Quality, Quality Laggards, Project Management Approaches, Cost and Economics of SQA, Quality Measurements, Software Requirements and SQA, Requirements Defects, Writing Quality Requirements, Quality Attributes of Requirements Document, Software Design Model and Software Design Defects, Quality Design Concepts, Programming and SQA, SQA Reviews, Software Inspections, Software Testing - WBT Techniques, BBT Techniques, Testing Strategies, Debugging, Test Planning, Automated Software Testing, Test Cases, Responsibilities of Testers; SQA and SCM, SCM Plan and SQA Plan, Process Assurance, Process Management and Improvement, Introduction to Quality Metrics, A Process Model of Software Quality Assurance.

Network Protocols and Standards

Common networking standards, services, & protocols- The OSI and TCP models of network communication, Routing & switching concepts, Commonly used network hardware, Network media and topologies, Multimedia Communication Protocols, Network Management Protocols, Sub-netting & VLANs Wireless Standards: IEEE 802.3, IEEE 802.11, IEEE 802.16, IEEE

802.15 etc. Routing and transport layer protocols standards and RFCs.

Advanced Data Warehousing

Strategic need of data warehousing, Building blocks of a data warehouse, Data warehouse project management, Business requirements of a data warehouse, Architectural components of a data warehouse, Data warehouse metadata management, Dimensionality Modeling, ETL & Data quality, Online Analytical Processing.



Wireless Sensor Networks

Introduction to wireless networks, architectures and technologies, Wireless sensor network platforms: Hardware and Software Communication architecture and protocols for WSN (MAC, Link, Routing), Energy management, Sensor data acquisition, processing and handling, Signal processing, target localization and tracking, self-organization, Modeling and Simulation of WSN, Application case studies (health, environmental monitoring, smart home)

Big Data Analytics

Introduction Hadoop and Map Reduce, Association Rules: Frequent item sets and association rule mining, Similar item sets and LSH, Near Neighbor Search in High Dimensional Data, Recommender systems, Link analysis: Personalized PageRank, Hubs and Authorities, Web spam and Trust Rank, Clustering, Descriptive analytics, Clustering, Dimensionality reduction: SVD a, Machine learning with massive datasets, Mining streaming data, Analysis of very large graphs, Time series data and streaming, Other application areas, Proximity search on Graphs: Random Walks with Restarts, Web Advertising

Computer Vision & 3D

Image formation and representation: imaging geometry, digitization, cameras and projections, rigid and affine transformations, Filtering: convolution, smoothing, Image Segmentation; Feature detection: edge detection, corner detection, line and curve detection, shape context descriptors. Model fitting: Hough transform, algebraic and Euclidean distance measures. Camera calibration: camera models; intrinsic and extrinsic parameters; affine, and perspective camera models. Epipolar geometry: introduction to projective geometry; epipolar constraints; the essential and fundamental matrices; Motion analysis: the motion field of rigid objects; motion parallax; optical flow, the image brightness constancy equation, affine flow; differential techniques; feature-based techniques; Motion tracking: the Kalman filter;

Object recognition and shape representation.

Text Mining

The fundamental issues in natural language processing along with the large volumes of unstructured electronic text that comes with heterogeneous input formats and intermediate representations; and the challenges in making system output coherent to user expectations; make text mining exciting. Applications of text mining are varied and include systems to support systematic reviews, to match candidate profiles to job profile, to discover favorable and unfavorable reviews, etc. The objective of this course is to get a good understanding of the basic text mining techniques and study some of its applications

Research Methods

Introduction to Research, Objectives of Research, Importance of Research Methodology in Research Study, Types of Research. Steps in Conducting Research, What is Literature Review?, Why need for Literature Review, Types of Literature Review, Systematic Literature Review Protocol, Problem Statement and Problem formulation. Criteria for selecting a problem, Identifying Types of variables in Research. Types of hypothesis, Sampling, Sampling Techniques, Data Analysis, How to write Good Research Proposal?, Contents of Thesis. Important Elements of Research Thesis.

Materials Science & Engineering

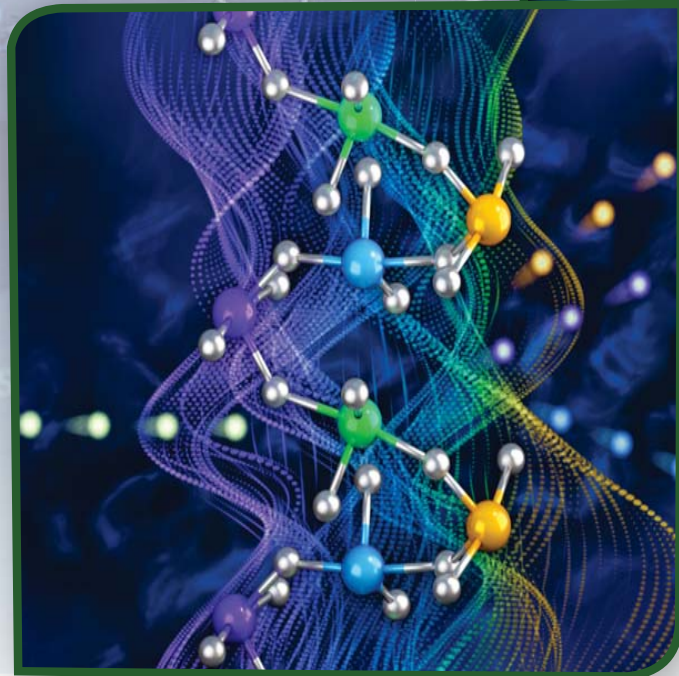

Materials Science & Engineering is a versatile and ever evolving discipline. It deals with structure, properties, applications of materials. Materials are studied in terms of their structural as well as functional properties and



applications. As the need for smaller and lighter materials grows, the desire for new materials, their design, fabrication and characterization becomes imperative. Institute of Space Technology offers MS Program in Materials Science & Engineering with focus on Aerospace Materials,

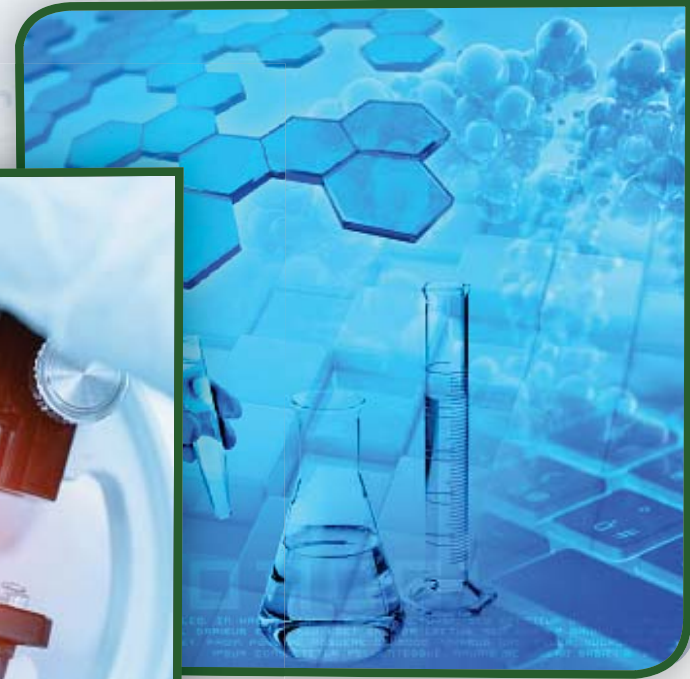

Functional Materials, Biomaterials, Nanotechnology, Composites and Coating that would enable students to attain an in depth understanding of the theoretical and practical aspects of materials. The program is attractive because of its rapidly expanding importance in both academic and industrial sectors.

Mission

The program aims to produce multidisciplinary professionals to be an effective part of research, design, production or technology development teams in conventional and advanced materials.

Prerequisites

- BS/ BE/ equivalent (16 Years of education) with strong background in Materials Science & Engineering, Metallurgy/Materials Engineering, Polymer Engineering, Physics, Chemistry/Chemical Engineering, Mechanical Engineering or Aerospace Engineering with minimum CGPA \geq 2.00 out of 4.00 or \geq 60% marks (where CGPA not available) from HEC and PEC recognized (where applicable) Institute/University or from Foreign Institute/University of good repute
 - GAT-A (General) conducted by NTS in the relevant field of study with \geq 50% marks or HAT (General) conducted by HEC in the relevant field of study with \geq 50% marks or GRE International (General) conducted by ETS, USA, with minimum score as Quantitative: 145, Verbal: 145, Analytical: 3.5
- The IST institutional code to receive GRE scores is 1758

Core Courses

Student has to take 3 core courses:

- Aerospace Materials (3-0)
- Thermodynamics of Materials (3-0)
- Mechanical Behavior of Materials (3-0)
- Research Methodology is a non-credited mandatory course

Student has to secure minimum 3.00 CGPA/4.00 in the course work.

MS Thesis (6 Credit Hours) is also compulsory for MS degree. Thesis defense will not be held if CGPA is less than 3.00 in course work. CGPA 3.00/4.00 separately in thesis is mandatory.

Note: Students has to study five elective courses; three must be from the MS&E Department. Elective courses are offered subject to the availability of specialized faculty and the number of students interested in a course.

Semester	Courses	Cr. Hr.
01	Aerospace Materials	03
	Elective I	03
	Elective II	03
02	Thermodynamics of Materials	03
	Research Methodology	0
	Elective III	03
	Elective IV	03
03	Mechanical Behavior of Materials	03
	Elective V	03
	Thesis I	03
04	Thesis II	03

Elective Courses

- Materials for Solar Energy
- Advanced Characterization Techniques
- Engineering Materials & Applications
- Materials for Energy and Environment
- Extraction of Materials
- Electrochemistry and Corrosion
- Metals and Alloys
- Composites for Aerospace Applications
- Polymer Engineering
- Composites
- Ceramics and Glasses
- Advanced Engineering Mathematics
- Mechanics of Composite Materials
- Processing of Materials
- Functional Materials
- Nano-Materials Engineering
- Nanotechnology
- Electronic and Magnetic Properties of Materials
- Thin Film Technology
- Electron Microscopy

- Spectroscopic Methods
- Semiconductors
- Coating & Tribology
- Phase Transformation & Kinetics
- Smart Polymers
- Preform Technology for Composites
- Finite Element Methods
- Solid State Physics



Course Description

Thermodynamics of Materials (611123)

Thermodynamics review. Laws of thermodynamics; property relation; free energies; Maxwell relations; chemical potential; thermodynamic activity. Statistical thermodynamics. Defects in solids, Surfaces and interfaces. Solidification, metallic glasses, diffusion, atomic mechanisms of diffusion, high-

diffusivity paths; diffusion in multiphase binary systems; diffusional transformations in solids, diffusion less transformations.

Mechanical Behavior of Materials (711119)

Review of types of materials; elastic, linear elastic and visco-elastic materials. Stress strain diagrams, elastic and plastic deformation. Plastic deformation of a single and polycrystalline materials; slip and

twinning. Tensile, compression, torsion, bend, impact and fracture toughness testing. Hall-Petch relation, spectrum of strain rate and its effect on the flow properties of materials. Strain hardening, strain rate sensitivity coefficients, anisotropy and R-value determination. Defects and imperfections in a single and polycrystalline materials; dislocations and their interactions, stress intensity factor, failure and fracture modes.

Griffith and Orowan theory of fracture. Fatigue, creep and stress rupture. Super plasticity, radiation damage and its effects on mechanical properties, Hydrogen embrittlement.

Aerospace Materials (711121)

A brief review of the fundamentals of materials and their types. Physical, mechanical and environmental properties. Review of phase diagrams. Structure of atmosphere, its major regions with their temperature profiles. Characteristics of the space environments. Requirements for aerospace materials. Evaporation effects on materials in space. Lightweight materials and their alloys for aerospace applications. High strength steels, stainless steels, super alloys and composites. Structure-property relations. Materials for pressure vessels and cryogenic applications. Extremely high temperature materials. Ablatives and thermal barrier coatings. Adhesives, lubricants, elastomers and advanced polymeric, ceramic and metal matrix composites for aerospace applications. Metallurgical assessment of space craft parts and materials. Effects of radiations on the performance of materials. Failure analysis and selection of materials.

Research Methodology (799909)

Research design and planning. Research methods and tools. Data analysis and interpretation. Research

proposal. Literature review and report writing. Important steps in writing a technical paper. Thesis writing. Plagiarism.

Materials for Solar Energy (611105)

The energy problem: causes, scope and scale. Solar Cells. Solar spectrum. Basic semiconductor physics: electron and hole energy bands; p-n junctions; photovoltaic effect, solar cell operation and characteristics; fill factor, efficiency; materials issues in solar cells; emerging solar cell technology; photovoltaic systems; grid tied versus battery backup; assessing energy resources.

Advanced Characterization Techniques (611124)

Modern methods of materials characterization. X-ray techniques, X-ray diffraction (XRD), X-ray Photoelectron Spectroscopy (XPS), Optical Microscopy and Spectroscopy, Ellipsometry, Fourier Transform Infrared Spectroscopy (FTIR), Raman spectroscopy, Scanning Electron Microscopy (SEM), Transmission Electron Microscopy (TEM), Scanning Probe Microscopy (SPM), Particle Beam Analysis, Secondary Ion Mass Spectroscopy (SIMS), Rutherford Backscattering Spectroscopy (RBS)

Engineering Materials and Applications (611135)

Atomic structure and bonding, crystal structure, structure of

polymers, defects in solids, diffusion in solids, mechanical properties of solids, phase diagrams, failure of materials, phase transformations, strengthening behavior, types and applications of materials, fabrication and processing of materials, corrosion and degradation

Materials for Energy and Environment (611140)

The world is facing energy crises and hazards to environment related with usage of various energy forms by the emission of excess of carbon. This course is related with the global issues/challenges of climate and energy, various methods of energy generation/storage, its efficient use, methods to capture and store carbon, climate engineering, and its impact on the environment

Extraction of Materials (611146)

Thermochemistry, chemical Equilibrium, melts and solutions, reaction kinetics, reactor design, phase Separation, fuel and ore preparation, reduction of metal oxides, smelting, refining processes, rare and reactive Metals, ferroalloys, hydrometallurgy, electrometallurgy, enthalpies of formation at 25C, enthalpy increments above 25C, standard Gibbs energies of formation and evaporation.

Electrochemistry and Corrosion (611214)

Electrochemical Concept of Corrosion, Faradaic and Non-

Faradaic Processes, Electrical Double Layer, Corrosion Cells, Corrosion Processes, Corrosion circuit, Cathodic and Anodic Reactions, Formation of Solid Products and their importance. Electrochemical Thermodynamics and Kinetics including charge transfer, polarization and mixed electrodes, Interface Potential Difference and Half-Cell, Nernst-Equation, Pourbaix Diagrams. Types of corrosion and their mechanisms, Galvanic Coupling, Corrosion of Active-Passive Metals and Alloys, Anodic Polarization and Passivity, Influence of Environmental Variables. Corrosion Rate Measurements, Tafel Analysis, Polarization Resistance, Electrochemical Impedance Spectroscopy, Cyclic Polarization Scans. Corrosion of welded structures and Micro-Biological Corrosion with case studies.

Metals and Alloys (611215)

Different methods of classification of steels, various phases and reactions in steel: ferrite reaction, bainite reaction, martensite formation. Alloy steels; effects of alloying elements. Stainless steels: ferritic, martensitic, austenitic, precipitation-hardening. HSLA steels, maraging steels, dual-phase steels, tool steels. Corrosion of stainless steels. Aluminum alloys. Magnesium alloys. Titanium alloys. Nickel-base superalloys. Nickel-iron-base superalloys. Cobalt-base superalloys.

Composites for Aerospace Applications (611309)

Introduction to composites for aerospace applications, Special purpose composites, High temperature resistant composites, Special structures in composite manufacturing, Joining techniques for composites, Machining of composites, Testing of Composites, Failure Criteria and Failure analysis. Damage assessment and repair of composites, Recycling and Disposal of composites.

Polymer Engineering (611312)

Control and design of structure and molecular weight. Determination of molecular weight. Step growth process, Chain polymerization. Copolymerization. Stereo-regularity of polymers, Polymerization processes, Morphology and Properties. Polymer testing. Polymer structure and stability. Hydrogels and dendrimers.

Composites (611314)

Historical background of composites; classification and general properties. Role of the constituent materials in composite manufacturing, i.e. matrices and reinforcements; their types, production and properties. Polymeric matrix composites (PMCs). Metal matrix composites (MMCs). Ceramic matrix composites (CMCs). General manufacturing techniques of PMCs, MMCs and CMCs and their principles. Special purpose composites. Fiber-matrix Interface

and interphase, and their role in tailoring the properties of composites. Interface mechanics and toughness. Design and analysis of composites. Elastic, thermal and physical properties. Thermal stresses in composites. Applications of composites. Joining techniques for composites. Machining of composites. Special structures in composite manufacturing; light weight structural cores; honeycomb cores, foams. Hybrid composites. The emerging field of nanocomposites. Composite materials as surface coatings. Testing of composites: constituent material testing, testing of lamina and laminate. Mechanical testing of composites. Full-scale structural testing. Non-destructive testing of composites. Failure analysis of composites. Recycling and disposal of composites.

Ceramics and Glasses (611406)

Bonding in ceramics; structure of ceramics; effect of chemical forces on physical properties; thermodynamics and kinetic considerations; defects in ceramics; diffusion and electrical conductivity; phase equilibria; formation, structure and properties of glasses, sintering and mechanical properties. Fracture, creep and fatigue. Thermal properties; dielectric properties; magnetic and nonlinear dielectric properties, optical properties.

Advanced Engineering Mathematics (623205)

Vector Calculus, Coordinate system transformation, Power series solution, Special functions, Bessel functions, Legendre polynomials, Laplace and inverse transforms, Solution of linear differential equations by the Laplace transform method, Introduction to PDE's, Functions of many variables and their geometries

Mechanics of Composite Materials (711120)

Introduction to composite materials; classification and characteristics of composite materials; mechanical behavior of composite materials; Lamina; Laminate characteristics and configuration; macro-mechanical behavior of a lamina; Stress Strain relation for anisotropic materials; Laminate theory; Stiffness; Compliance and Engineering constants for orthotropic materials; Stress strain relations for plane stress in orthotropic materials. Invariant properties of an orthotropic lamina; Strength of orthotropic laminas; Biaxial strength theories for an orthotropic lamina; Micromechanical behavior of a lamina; Macromechanical behavior of a laminate. Classical lamination theory; Special cases of laminate stiffness; Theoretical versus measured laminate stiffness; Strength of laminates; Interlaminar stresses; Bending; buckling and vibration of laminate plate; Fatigue of composites; Hygrothermal effect; Design of composite structures.

Processing of Materials (711132)

Introduction to materials processing science with emphasis on heat transfer, chemical diffusion and fluid flow. Synthesis and production of materials with engineered microstructures for desired properties. High temperature, aqueous, and electrochemical processing; thermal and mechanical processing of metals and alloys; casting and solidification; diffusion, microstructural evolution, and phase transformations; modification and processing of surfaces and interfaces; deposition of thin films; solid state shape forming; powder consolidation; joining of materials.

Functional Materials (711133)

Nature and types of solid materials, Binding forces in solids and essential elements of crystallography, Ferro electric, para electric and pyro electric materials, piezo electric materials, polarization mechanisms, magnetic materials and properties, optical materials and properties, sensor/actuator materials, semiconductors, electroceramics, shape memory materials, methods of materials characterization

Nano-Materials Engineering (711138)

Synthesis and characterization of nanoparticles, nanocomposites and other materials with nanoscale features. Nanofabrication techniques. Zero-dimensional nanoparticles. One-dimensional nanostructures e.g. nanotubes,

nanorods, nanowires and nanofibers. Two dimensional thin films. Design and properties of devices based on nanotechnology. Importance of nanostructured materials. Structure-property-processing relationship in nanomaterials and uses in electronics, photonics, magnetic applications.

Nanotechnology (711139)

Introduction. Moore's Law. Richard Feynman prediction. Size dependent properties at nanoscale. Molecular nanotechnology, Top-down and bottom-up approach; size dependence on properties; materials and processes; silicon technology; semiconductor grade Silicon; silicon single crystal growth and wafer production; photolithography; Soft-lithography; clean room; impact of nanotechnology; impact of nanotechnology on information technology, materials and manufacturing, health and medicine, energy, environment, transportation, security and space exploration. Quantum mechanics and nanotechnology. Thin film technology. Bio-Inspired nanotechnology. Impact of nanomaterials. Ethics and dangers of Nanotechnology.

Electronic and Magnetic Properties of Materials (711141)

Semiconductors; binary and tertiary semiconductor materials; single crystal growth techniques; doping profiles; VLSI technology; magnetic moment; classification of magnetic

materials; magnetization curves; domain theory; soft and hard magnetic materials; magnetic materials processing; cast and sintered magnets; magnetostriction; metallic and ceramic magnets.

Thin Film Technology (711142)

Review of vacuum science and technology. Methods of preparation of thin films: electrolytic deposition; cathodic and anodic films, physical vapor deposition. The physics and chemistry of thermal evaporation. Film thicknesses; uniformity and purity, Evaporation hardware and techniques, Glow discharges and Plasmas; sputtering, sputtering processes; laser ablation hybrid and modified PVD processes; chemical vapor deposition: reaction types, thermodynamics of CVD, gas transport, growth kinetics, CVD processes and system, Growth and structure of films; atomistic nucleation processes; post-nucleation growth; film structures; structural aspects of epitaxial films; lattice misfit and imperfection in epitaxial films; Epitaxial Film growth and characterization; amorphous thin films.

Electron Microscopy (711143)

Basic principles of imaging and diffraction, basic principles of beam interactions and electron microscopy, lenses and defects, radiation damage, Scanning Electron Microscopy (SEM), Specimen Preparation, Variable Pressure SEM, Energy Dispersive Spectroscopy (EDS) in SEM, Transmission Electron

Microscopy (TEM), Scanning TEM and EDS, Energy Filtered TEM and Electron Energy Loss Spectroscopy (EELS)

Spectroscopic Methods (711144)

Atomic absorption spectroscopy, UV-VIS spectroscopy, mass spectroscopy, Infrared and Raman spectroscopy, nuclear magnetic resonance spectroscopy, photoelectron and Auger electron spectroscopy, XPS.

Semiconductors (711147)

Energy band and carrier concentration in thermal equilibrium, carrier transport phenomenon, semiconductor devices: PN junction, Bipolar transistor and related devices, MOSFET and related devices, MESFET and related devices, Microwave diodes, quantum-effect and hot-electron devices, photonic devices

Coating & Tribology (711162)

Advance coating techniques, thermal spray coatings, materials used for spraying, pre-spray treatment, post spray treatment, physics and chemistry of thermal spraying, coating buildup, method of coatings characterization of coatings, quality and properties of coatings, application of coatings in aeronautical and space industries, oil and gas industry, chemical industry, civil engineering, decorative coating, electronics industries, energy generation and transport, iron and

steel industries, nuclear industries, ship building and naval industries, type of wear, wear mechanism, erosion and corrosion in industries.

Phase Transformation & Kinetics (711168)

Thermodynamic concepts of Gibbs Free Energy, Enthalpy, Entropy. Kinetics, diffusion. Interfaces of crystal structures and microstructures. Diffusional and diffusion less transformations

Smart Polymers (711310)

Introduction to smart polymers, Chemical responding polymers, Thermo-responsive polymers, pH sensitive polymers, Electroactive polymers, Light responding polymers, Magnetic responsive polymers, Self-healing polymers, Multiple stimuli polymers, Smart polymer hydrogels, Polymers for drug release, Shape memory polymers, Conductive polymers, Fire retardant polymers. Their design, structure, properties and characterization. Outlook for the future

Preform Technology for Composites (711313)

Introduction to composites reinforcements, One-dimensional preforms, Two-dimensional preforms, Random fibre preforms, Preforms based on uni-directional layers, Woven reinforcements, braided reinforcements, Knitted reinforcements, Solid three-dimensional preforms, Sandwich

preforms, Preform architecture and mechanical behaviour of reinforcements/preforms, General approach to modeling of mechanical properties of reinforced composites, Representative volume element (unit cell) of composites, description of the unit cell geometry as a starting point for prediction of mechanical properties

Finite Element Methods (714808)

Introduction to Finite Element Methods (FEM), mathematics preliminaries, truss analysis, variational and weighted residual formulations, general approach to structural analysis, efficient representation of computational meshes, efficient computation of the

element tensor (element stiffness matrix), tensor representation of multilinear forms, Stress analysis for one and two dimensional problems of structures, beam analysis, and ANSYS software for FEA analysis

Finite Element Methods (714808)

Introduction to Finite Element Methods (FEM), mathematics preliminaries, truss analysis, variational and weighted residual formulations, general approach to structural analysis, efficient representation of computational meshes, efficient computation of the element tensor (element stiffness matrix), tensor representation of multilinear forms, Stress analysis for one and two dimensional problems

of structures, beam analysis, and ANSYS software for FEA analysis

Solid State Physics (717405)

Crystal vibrations, thermal properties, free electron Fermi gas, energy bands, Fermi surface and metals, superconductivity, diamagnetic and paramagnetism, ferromagnetism and antiferromagnetism, Magnetic resonances, Plasmon's, Polaritons and Polarons, Optical Processes and Excitons, Dielectrics and Ferroelectrics, Surface and Interface Physics, Non crystalline solids, point defects, Dislocations, alloys

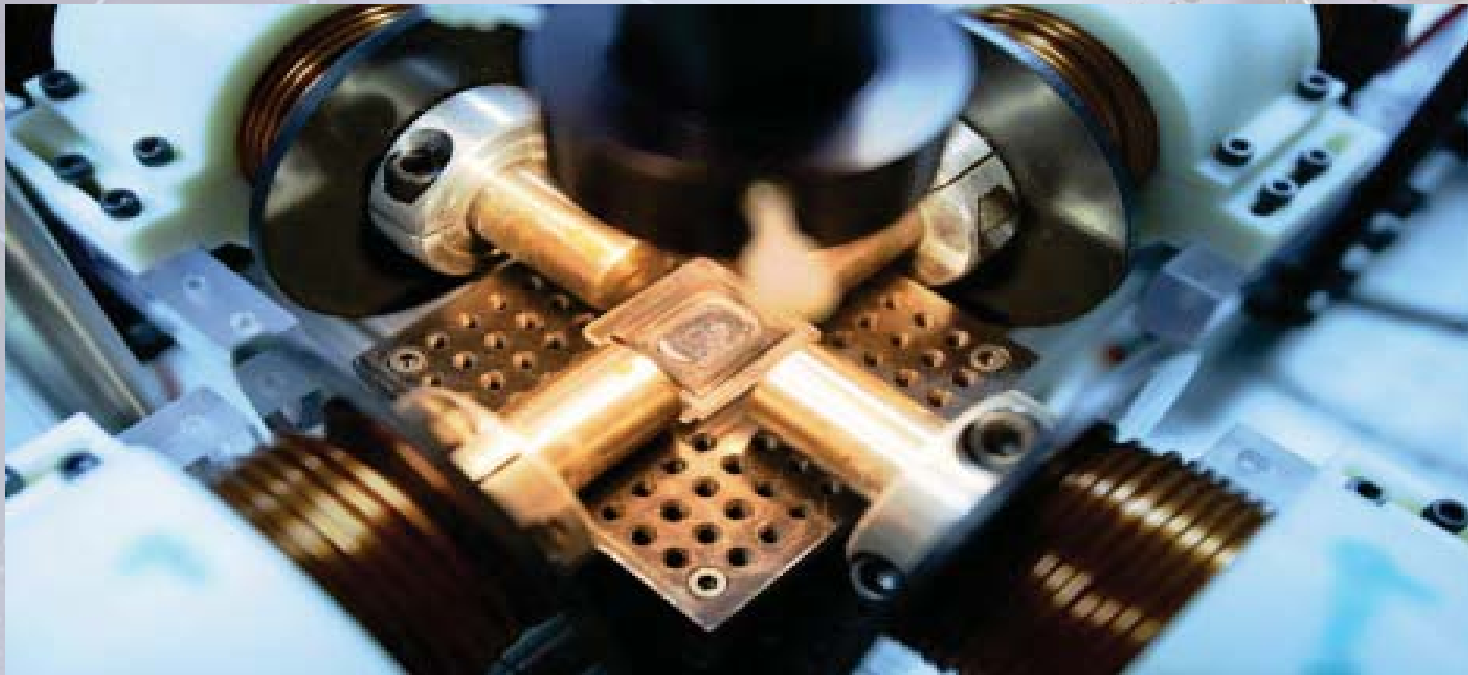

PhD in Materials Science & Engineering

Eligibility Criteria

- MS/ M.Phil/ equivalent (18 Years of education) with a strong background in relevant discipline with minimum CGPA 3.00 out of 4.00 or First Division (where CGPA not available) from HEC/PEC recognized Institute/University or from Foreign Institute/University of good repute
- Valid GAT-A (General - Engineering Category) conducted by NTS with $\geq 60\%$ score or Valid HAT-I (Engineering Category) administered by the Education Testing Council (ETC-HEC) with $\geq 60\%$ score or GRE International (General) conducted by ETS, USA, with minimum score as Quantitative: 145, Verbal: 145, Analytical: 3.5 or Valid GAT (Subject) conducted by NTS in the relevant field of study with $\geq 60\%$ score or Minimum 60% marks in test equivalent to GRE/ HAT General/ Subject conducted by the Higher Education Institution (HEI). The IST institutional code to receive GRE scores is 1758.

Research Prerequisites

- Statement of purpose (intended research work during PhD) approved by departmental board of graduate studies (DBGS)
- PhD candidate will be required to give a presentation on the research topic proposed in the statement of purpose to the DBGS

Course work

- To fulfill the minimum requirement of 18 credit hours of course work, students have to take three mandatory courses and three elective subjects. Afterwards, the student has to qualify a comprehensive examination. Student also has to take 24 credit hours of PhD thesis as

Thesis-I (6 credit hours), Thesis-II (6 credit hours), Thesis-III (6 credit hours) and Thesis-IV (6 credit hours)

- Migration/Transfer of the courses from other Universities/Institutes is allowed as per IST Migration/Transfer policy
- The PhD supervisor and a list of 6 PhD courses to be taken by the scholar must have been approved by Departmental Board of Graduate Studies.

Semester	Courses	Cr. Hr.
01	*Advanced Aerospace Materials	03
	*Advanced Characterization Techniques II	03
	Elective I	03
	Elective II	03
02	*Thermodynamics of Materials II	03
	Elective III	03
	Elective IV	03
	Elective V	03
Summer Semester	Comprehensive Exam and Synopsis Defense	
03	Research Methodology (non-credit)	03
	Thesis I	06
04	Thesis II	06
05	Thesis III	06
06	Thesis IV	06

*These are mandatory courses but students who have studied them in MS can be allowed to take other relevant courses from the list of electives. Nevertheless, if the students intends to take these courses, their assessment (Exams, Assignments etc.) will be different from those who are taking them as fresh/new courses.

Comprehensive Examination

Qualifying test is conducted after successful completion of the course work.

- The test comprises of a written exam and a presentation along with an oral defense
 - A Minimum of 60 % marks are required to pass comprehensive exam in both written and oral part
 - Students who fail in comprehensive exam is allowed to reappear once in the test only
- After passing the comprehensive exam, the student have to defend his/her synopsis in Graduate Studies & Research Council (GSRC) prior to registering the research work

Research Work

- 24 credit hours of research work has to be completed, spanning over at least two years through continuous registration in Thesis-I, Thesis-II, Thesis-III, and Thesis-IV of 6 credits each
- Doctoral Dissertation
 - Each PhD researcher shall be required to write a doctoral dissertation
 - A plagiarism test in accordance with the HEC's Plagiarism Policy is conducted on the dissertation before its submission to the examiners
 - An open public defense is conducted after the approval

of dissertation by a committee of faculty member

Award of PhD Degree

A PhD degree will be awarded to the students after completing the following requirements

- Successful completion of course work (18 credit hours)
- Successful completion of comprehensive examination
- Successful presentation/defense of Synopsis
- Two research publications in HJRS indexed journals with at least 1 of them being in an Honorable category
- At least two evaluations by the experts from technologically advanced countries, defined by HEC (Foreign experts)
- Changes in the IST-PhD policy can be made at any time as per HEC recommendations

Elective Courses

- Smart Materials
- Advanced Surface Engineering and Coatings
- Surface and Interfaces
- Magnetic Materials
- Advanced Welding and Joining
- Semiconductor Materials
- Thermal Spray Coating
- Advanced Processing of Materials
- Mechanical Behavior of Materials
- Extraction of Materials
- Thermoelectric Materials and Devices
- Electroceramics
- Density Functional Theory

Methods and Applications

- Condensed Matter
- Bio-Interfaces Nano Biomaterials
- Advance Metals and Alloys
- Advanced Composite Materials
- Mechanics of Composite Materials
- Advanced Ceramic and Glasses
- Nano chemistry for Nano Engineering
- Biomaterials
- Modeling & Simulation
- Mathematics for Materials Science
- Tribology and Lubrication
- Advanced Microscopy Techniques
- Micro/Nano Systems and Technologies
- Phase Transformation and Kinetics
- Deformation and Fracture of Materials
- Smart Polymers
- Chemical Synthesis

Note: The elective courses will be offered from the list subject to the availability of specialized field of faculty and number of students interested in the course

Course Description

Advanced Aerospace Materials (811148)

Intensifying demands of properties of aerospace materials, Mission demands, New challenges, Increasing efficiencies and powers of engines, Metallic materials – classical alloys, smart materials, refractory metals, new trends, Ceramic materials – recent developments, New trends in polymeric materials,

Development of various fiber materials for composites, New trends in composite materials, Advances in coatings for aerospace materials

Thermodynamics of Materials II (811150)

Thermodynamics Laws, Criteria of Spontaneity, Use of Thermodynamic data, Phase Equilibria, Thermodynamics of chemical and electrochemical reactions, thermodynamics of surfaces and defects in materials, Thermodynamics of Phase Transformations

Advanced Characterization Techniques II (911149)

This course covers basic to advance topic on materials characterizations including: Scanning/Transmission electron microscopy (Imaging, EDX and WDS), STEM, X-ray analysis (diffraction, absorption, fluorescence, structure analysis, energy dispersive analysis), Surface analysis (X-ray photoelectron spectroscopy and secondary ion mass spectroscopy), vibration spectroscopy (Infrared and Raman), Thermal analysis (TGA, DSC). Atomic force microscopy. In-Vivo, In-Vitro and In SITU characterization techniques.

Smart Materials (811151)

Classification, Application Areas, Piezoelectric Materials, Piezo effect, Piezoelectric Materials, Ferroelectricity, Fabrication,

Applications, Magnetostrictive Materials, Magnetostriction, Cryogenic Materials, Rare Earth - Fe phases, Thin Film Materials, Applications, Shape Memory Alloys, Shape Memory Effects, Super elasticity, TiNi - based materials, Shape Memory Thin Films, Applications, Multiferroic Materials, Magnetic Shape Memory Materials, Magneto-electric Composites

Advanced Surface Engineering and Coatings (811152)

Philosophy of surface engineering, General Applications and Requirements, Principles and design of coatings, Physics of the plasma state and plasma surface interactions, Surface engineering as part of a manufacturing process, integrating coating systems into the design process, Coating manufacturing processes, Electro deposition, Flame spraying, Plasma spray, Physical vapor deposition, Chemical vapor deposition, HIP surface treatments, Sol-gel coatings, Spin coating methods

Surface and Interfaces (811154)

Surface and interfaces; Preparation of well-defined surfaces, interfaces and thin films; requirement of ultrahigh vacuum; Epitaxial growth; Layer-by-layer growth and island formation; Epitaxial growth by chemical reactions; Surface Stress, Surface Energy, and Macroscopic Shape; Relaxation, Reconstruction,

and Defects; Structural Models of Solid-Solid Interfaces; Nucleation and Growth of Thin Films; Film-Growth Studies: Experimental Methods and Some Results; Kinematic Theory of Surface Scattering; What Can We Learn from Inspection of a LEED Pattern?; Kinematics of an Inelastic Surface Scattering Experiment; Dielectric Theory of Inelastic Electron Scattering; Rutherford Back Scattering (RBS); Electronic Surface States; Adsorption on Solid Surfaces

Magnetic Materials (811157)

Fundamentals of magnetism, Manifestations of magnetism, Magnetic anisotropies, Magnetization processes, Magnetic domains, Soft magnetic materials, Hard magnetic materials, Spin electronics and magnetic recording, Spin transfer torque effect and devices, Advanced magnetic domain observation techniques, Permanent magnet materials for sustainable energy, Magneto caloric materials, Electric field induced changes of magnetism, Manipulation of cells by magnetism, Magnetization dynamics, Micro magnetic calculations, Spin calorics, Bio magnetism

Advanced welding and Joining (811158)

Gas metal arc welding, Advances in GMAW, Process measurements and control, Hybrid processes, Future trends, Tubular cored wire welding, principle, equipment, Advantages and disadvantages, Gas tungsten

arc welding, keyhole GTAW process, Future developments, Laser beam welding, process, principle, Application of Laser beam welding, Laser output characteristics, Laser as a machine tool, New developments in Laser welding, Electron beam welding, Electron beam welding machine, Explosion welding, Developments in explosion welding, Capability and limitation, Ultrasonic metal welding, mechanics and metallurgy of ultrasonic welding.

Semiconductor Materials (811159)

Band theory, Essentials of the Free Electron Gas, Energy Gaps and General Band Structure, Band Structures and Standard Representations, Semiconductor physics, intrinsic properties in equilibrium; Doping, carrier, concentration, mobility, and conductivity, Junctions and devices, Fundamentals of optoelectronics, Materials and radiant recombination, Recombination and luminescence, Doping of compound semiconductors, Wavelength engineering; Light and semiconductors, Total efficiency of light generation, Absorption and emission of light, modulation doping, and quantum effects, Real heterojunctions, Quantum devices, Single and multiple quantum wells, Principles of the semiconductor LASER, LASER conditions; Interaction of light and electrons and inversion; Light amplification in semiconductors, from amplification to oscillation, Second Laser

condition, Laser modes, Light emitting devices, Basic requirements and design principles; Products, market, materials, and technologies; Selected LED concepts, Optimizing light confinement and gain in Laser diodes, Special Semiconductor, Silicon carbide, Materials aspects and applications.

Thermal Spray Coating (811160)

Materials Used for Spraying, Methods of Powders Production Synthesis (SHS), Methods of Powders Characterization, Feeding, Transport and Injection of Powders. Pre-Spray Treatment Introduction, Surface Cleaning, Shaping, Surface Activation, Masking. Thermal Spraying Technique, Atmospheric Plasma Spraying (APS), Arc Spraying (AS), High-Velocity Oxy-Fuel (HVOF) Spraying, Cold-Gas Spraying Method (CGSM), New Developments in Thermal Spray. Post-Spray Treatment, Thermally Sprayed Composites. Methods of Coatings' Characterization, Methods of Microstructure Characterization. Mechanical Properties of Coatings, Characterization of Coatings' Quality. Properties of Coatings Design of Experiments, Mechanical Properties, Corrosion Resistance. Applications of Coatings in Industrial and aerospace applications

Advanced Processing of Materials (811161)

Synthesis and Production of materials with engineered micro

structures of desired properties. High temperature and electrochemical processing, thermal and mechanical processing of metal and alloys, casting and solidification, diffusion, microstructure evolution, modification and processing of materials, deposition of thin films, shape forming, powder metallurgy, joining of materials.

Mechanical Behavior of Materials (811163)

Elastic and Plastic Deformation, Tests for Plastic deformation, Slip & Twinning, Dislocation Theory, Flow Properties, Plane Stress and Plane Strain, Embrittlement, Fracture Toughness, Fatigue, Creep, Superplasticity

Extraction of Materials (811169)

This course is related to the science and engineering of metals extraction from ores. Thermodynamics, phase separation chemistry and energy changes and involvement during metal extraction will be discussed. The difference in ore and gangue mineral properties and separation of the two materials based on these properties will be discussed

Thermoelectric Materials and Devices (811170)

Introduction to thermoelectricity, Thermoelectric effects: Seebeck effect, Peltier effect and Thomson effect, Criterion for good thermoelectric material: Thermoelectric figure-of-merit (ZT),

The Boltzmann Equation and the Distribution functions: Electrical conductivity, Seebeck coefficient and Thermal conductivity, Strategies towards enhancement of Figure-of-Merit (ZT): optimization of key parameters through composition tuning, Different methods for the production of materials, Measurement Techniques and apparatuses for thermoelectric transport properties, Thermoelectric Devices: Power Generators, Solid State Refrigerator and Heaters, Commercial applications of thermoelectric devices, Thermoelectric properties of metals, semiconductors, composites and alloys, Discovery and design of new thermoelectric materials, Thermoelectric properties of nanostructured materials, Current research on thermoelectric materials.

Electroceramics (811172)

Introduction; elementary solid state science, Processing of Ceramics, Powder Metallurgy, Synthesis of powders, Powder characterization, Colloidal processing, Sol-gel Processing, Powder consolidation and forming of ceramics, Sintering of ceramics, Grain growth and microstructural control, Problems in sintering, Densification process variables and densification practice, Ceramic Conductors; Dielectric and Insulators, Dielectric strength, Ceramic types and applications; Piezoelectric ceramics, Important commercial piezoceramics, Lead zirconate titanate, Barium titanate; Pyroelectric Materials; Electro-optic ceramics.

Density Functional Theory Methods and Applications (811173)

Review of Density Functional Theory (DFT). Density Functional Theory Methods. Materials Design, Modeling, and Simulations Using Density Functional Theory Calculations. Crystal & Electronic Structures, Magnetic Properties. Ab Initio Molecular Dynamics. Accuracy and Methods beyond "Standard" Calculations.

Condensed Matter (811174)

Electrons in the Periodic Crystal - Band Structure. Semiconductors and Semiconductor Devices. Theory of Metals. Charge Excitations. Phonons in Metals. Dynamics of Phonons and the Dielectric Function. Transport properties of semiconductor and conductor materials. Magnetism in Metals.

Bio-Interfaces (811175)

Course starts with fundamental electrostatics at interfaces and includes a detailed description of fundamental theories dealing with electrical double layers around a charged particle, electrokinetics, and electrical double layer interaction between charged particles. The stated fundamentals are provided as the underpinnings of sections, which address electrokinetic phenomena that occur in nanoscience and bioscience. Applications in biomaterials, stem cells, microbiology, water purification, and humic substances are discussed

Nano Biomaterials (811176)

Introduction to Nano biomaterials. Importance of nano materials in the design of biomedical devices. Role of sol-gel technology in the synthesis of nano-biomaterials. Carbonaceous (CNTs, Graphene) materials for drug delivery. Toxicity challenges associated with nanomaterials. Microbial cell encapsulation and gene encoding. Protein adsorption phenomenon. Hydrogels and bioactive nanoparticles. 3D-printing and melt electro writing of nano biomaterials. Cell biology studies of nano scale materials. Applications in dental, cartilage repair, skin tissue engineering, cardiovascular devices, and bone tissue engineering will be discussed. Design feature of biomedical devices and available classes.

Advance Metals and Alloys (811218)

The course focuses on the materials used in advanced applications. It inculcates understanding of factors that govern the design and selection of metallic materials. Modern processing procedures and resultant properties will be discussed for selected alloys from different systems. Manufacturing and processing technologies will be explored and understanding of the relationships between composition, microstructure, processing and performance will be developed. An important module will be the assessment of materials performance in service and develop an understanding of the processes

of degradation in hostile conditions. This course requires knowledge and a strong materials background to develop specialized knowledge of the principles, structure, processing and design of advanced engineering materials. At the same time, the course will be kept flexible to accommodate graduates from other engineering and science backgrounds who wish to specialize in materials engineering.

Advanced Composite Materials (811311)

This course aimed at students with ample background in composite materials and wish to gain specialized knowledge in composite field for aerospace applications. In-depth understanding of composite materials and their key factors which influence the design of such advanced materials. Classification and characteristics of composite materials. Macro, micro and meso-mechanics of composites for aerospace structures. Stress Strain relation for anisotropic materials; Laminate theory; Stiffness; Compliance and Engineering constants for orthotropic materials; Stress strain relations for plane stress in orthotropic materials. Classical lamination theory. Fatigue of composites; Hydrothermal effect; Design of composite structures. Sandwich structures and their theory. Advanced MMCs, CMCs, and FRPs. Non-destructive evaluation of Composites by different techniques including UT (Ultrasonic testing) and DIC (digital Image correlation). FEM

usage for advanced composite materials by using different commercial tools (ABAQUS, ANSYS, LS-DYNA etc)

Mechanics of Composite Materials (811316)

Introduction to composite materials; classification and characteristics of composite materials; mechanical behavior of composite materials; Lamina; Laminate characteristics and configuration; macro-mechanical behavior of a lamina; Stress Strain relation for anisotropic materials; Laminate theory; Stiffness; Compliance and Engineering constants for orthotropic materials; Stress strain relations for plane stress in orthotropic materials. Invariant properties of an orthotropic lamina; Strength of orthotropic laminas; Biaxial strength theories for an orthotropic lamina; Micromechanical behavior of a lamina; Macromechanical behavior of a laminate. Classical lamination theory; Special cases of laminate stiffness; Theoretical versus measured laminate stiffness; Strength of laminates; Interlaminar stresses; Bending; buckling and vibration of laminate plate; Fatigue of composites; Hydrothermal effect; Design of composite structures.

Advanced Ceramic and Glasses (811407)

Bonding in ceramics, Physical, thermal and mechanical behavior, Powder processing, shape forming processing, Sintering, Principles of glass formation, Glass melting,

viscosity of glass forming melts, Glass technology, composition and properties of commercial glasses, Ceramic matrix composites.

Nano chemistry for Nano Engineering (811504)

Emergence of the fields, State of the Art and Challenges, Surface Science and Surface energy, Nano chemistry, Dimensionality and Materials, Nano synthesis, Homogenous and Heterogeneous Nucleation, Sol-Gel-Synthesis, Forced hydrolysis, Solid state phase segregation, Kinetically confined synthesis, Seeding, Micelles and micro emulsion, Aerosol, Spray Pyrolysis, Microwave, Template-based synthesis, Carbon Fullerenes and Nanotubes, Micro and Mesoporous, Core-shell structures, Organic/Inorganic hybrids, Nanocomposite, Intercalation, Green Nano synthesis, Nano patterning, Self-assembly and self-organization, Capillary forces, Dispersion Interaction, Shear force assisted assembly, Electric field assisted assembly, Covalently linked assembly, Template assisted assembly, Green Nano patterning, Nano engineering.

Biomaterials (811505)

Introduction to Biomaterials, Biocompatibility, biocompatibility issues of biomaterials, how to overcome these issues, Bio functionality, In vitro and in vivo testing, Tissue -biomaterial interactions, biological response with bio-materials, Metallic biomaterials, Organic biomaterials, Biomaterials

processing and synthesis, Hydroxyapatite (HA) coatings, Materials selection for implants and prostheses, Dental materials, Orthodontic wires Shape memory alloys, Use of Titanium and Ni-Ti alloys as biomaterials, Corrosion and biodegradation of biomaterials, Stress shielding effect, how to overcome stress shielding effects Applications of biomaterials.

Modeling and Simulation (815220)

This course provides modeling and simulation approaches, covering continuum methods (e.g. finite element analysis), atomistic simulation (e.g. molecular dynamics) as well as quantum mechanics. Atomistic and molecular simulation methods are new tools that allow one to predict functional material properties directly from the chemical makeup of the material by solving Schrodinger's equation (quantum mechanics). This approach is an exciting new paradigm that allows to design materials and structures from the bottom up to make materials greener, lighter, stronger, more energy efficient, less expensive; and to produce them from abundant building blocks. These tools play an increasingly important role in modern materials science and engineering.

Mathematics for Materials Science (823220)

Matrices & Linear Transformations, Fourier Transformation, Line and Surface Integrals, Gamma, Beta and

Error Functions, Laplace Transformation, The Wave Equation, Equation of Heat Conduction or Diffusion, Finite Differences, Computational Materials Science

Tribology and Lubrication (911153)

Surface Topography, Physico-Chemical Aspects of Solid Surfaces, Surface Interactions, Mechanics of solid contacts, Elastic Contacts, Elastoplastic Contacts, Fracture, Friction, Laws of Friction, Mechanisms of Friction, Friction Space, Stiction, Stick Slip, Surface Temperature, Wear, Adhesive Wear, Delamination Wear, Fretting Wear, Abrasive Wear, Erosive Wear, Corrosive Wear, Mild and Severe Oxidational Wear, Melt Wear, Wear-Mechanism Maps, Lubrication, Boundary Lubrication, Solid-Film Lubrication, Mixed Lubrication, Hydrodynamic Lubrication, Hydrostatic Lubrication, Nanoscale tribology, Interatomic Interactions, Atomic Force Microscope (AFM), Challenges of Tribological Testing at Small Scales, Tribological testing, Common Geometries, Instrumentation and Methods Used for Testing, Influences of Test Parameters, Applications/Case Studies, Sliding Contacts, Rolling Contacts, Bearing Design, Coating Selection. Optional topics include: Electric Contacts, Microelectromechanical Systems (MEMS), Design of Tribological Surfaces, and Troubleshooting.

Advanced Microscopy Techniques (911155)

Scattering and diffraction, Elastic scattering, Inelastic scattering, Electron sources, Lenses aperture and resolution, Pumps and holders, The transmission electron microscope, Specimen preparation, diffraction from crystals, Imaging, Qualitative X-ray analysis

Micro/Nano Systems and Technologies (911156)

Introduction to Micro and Nano systems technology, Cleanroom technology, Optical and electron beam lithography, Thin film deposition: PECVD, sputtering, evaporation, pulse laser deposition, Wet and dry etching, Optical and scanning electron microscope inspection, MEMS materials, MEMS technologies, Doping of silicon, Micromechanical sensors, Piezoelectric transducers, Thermal sensors and actuators, MOEMS, MEMS packaging

Phase Transformation and Kinetics (911216)

Introduction, definitions, classification of phase transformations, Homogeneous nucleation theory, Transient nucleation, Heterogeneous nucleation theory, Nucleation in alloys, Spinodal decomposition, Interface controlled thermally activated growth, Diffusion controlled growth, Formal theory of transformation kinetics, Polymorphic, massive, and precipitation transformations, Kinetics of

coarsening, Order-disorder transformations, Diffusion less transformations, Characteristics of martensitic transformations, Crystallography of martensitic transformations, Kinetics of martensitic transformations, Shape memory alloys, Bainitic transformations, Amorphous materials; metallic glasses, Block copolymers, semi crystalline polymers, Quasi crystalline materials, Nano crystalline materials

Deformation and Fracture of Materials (911217)

Elastic deformation, Plastic deformation, Theories of plasticity, Slip & Twinning, Strengthening mechanics, Fracture mechanics, Ductile and brittle fracture, Effect of service conditions on failures, Fracture in composites, Residual stresses.

Smart Polymers (911315)

Introduction to smart polymers, Chemical responding polymers, Thermoresponsive polymers, pH sensitive polymers, Electroactive polymers, Light responding polymers, Magnetic responsive polymers, Self-healing polymers, Multiple stimuli polymers, Smart polymer hydrogels, Polymers for drug release, Shape memory polymers, Conductive polymers, Fire retardant polymers. Their design, structure, properties and characterization. Outlook for the future.

Chemical synthesis (911506)

The main objective of this course to get understanding of various synthetic routes coupled with chemical modification methods such as alkylation, sulfonation, esterification etc., also it covers development and modernization of lightweight materials such as x-aerogels, x-foam, x-nanofiber etc. for aerospace applications.

Advanced Materials for Tissue Engineering (811177)

The course provides PhD students with an in-depth exploration of innovative materials and techniques in the field of tissue engineering. It covers the design, fabrication, and application of biomaterials used to create tissue scaffolds, with a focus on how these materials interact with biological systems. Students will learn about advanced topics such as bioactive materials, hydrogels, nanomaterials, and 3D printing technologies, as well as the critical considerations in biocompatibility and biodegradability. Through a combination of lectures, laboratory work, and case studies, the course aims to equip students with the knowledge and skills to contribute to the development of next-generation tissue engineering solutions.

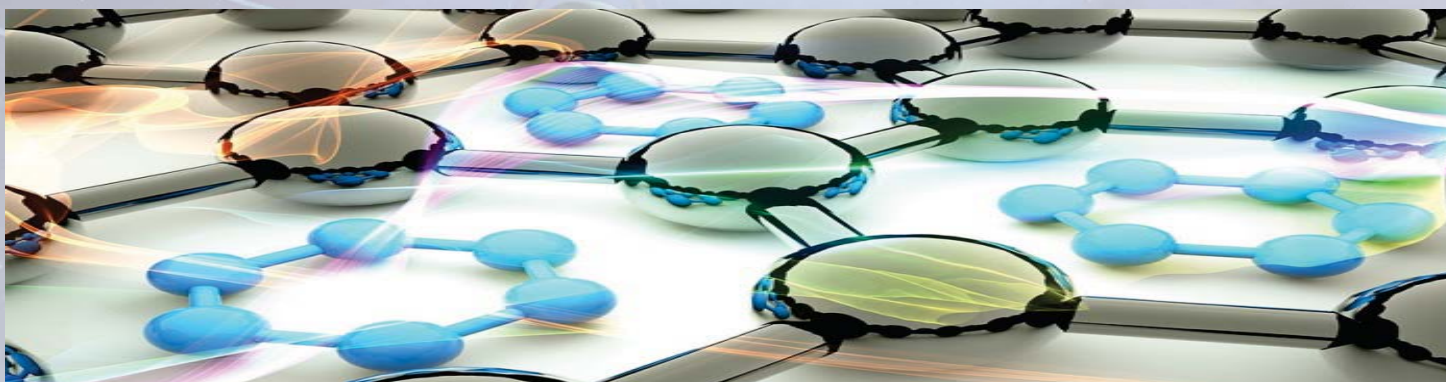

Note: Changes in PhD policy can be made to keep it in compliance with HEC guidelines and rules & regulations. These can be issued without any prior notice and shall be applicable to all students instantly.

Mechanical Engineering

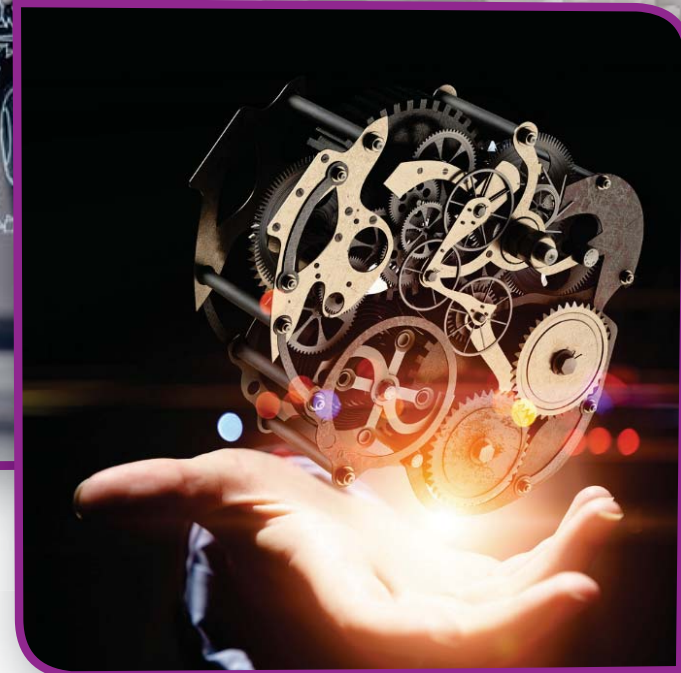

The Department of Mechanical Engineering (DME) offers a graduate program that aims to educate aspiring engineers who will lead the field in improving engineering systems. The program specializes in various areas such as Fluid and Thermal Systems, Mechanical Design and Analysis, Manufacturing Systems, Automobile, Dynamics and Controls. These areas bring together faculty and young engineers with a shared interest in research and innovation, providing opportunities for advanced studies. The program emphasizes research and innovation, connecting strongly with industry and dedicated research teams of the ME and allied departments. Mechanical Engineering

involves designing, developing, manufacturing, and operating a wide range of energy conversion and machine systems. Although rooted in mechanical engineering, the graduate program is interdisciplinary. Students are encouraged to develop the capability to use engineering analysis tools to solve a broad spectrum of industry problems. Faculty supplement coursework with ongoing research, and industry provides feedback to prepare young engineers for technical

innovation and leadership. With experienced faculty and dedicated staff, DME is well-equipped to face the challenges of the competitive world. Innovation and excellence require unremitting work and improvement efforts. We invite you to face these challenges with us.

Mission Statement

To serve the community by offering quality education and preparing engineering professionals capable of contributing through sustainable solutions with a focus on research, development, and innovation in mechanical and allied disciplines.

Program Educational Objectives

- Apply advanced knowledge and methodological skills to conduct independent and original research in mechanical and allied disciplines

- Demonstrate the traits to cognize the social and ethical standards
- Enhance their professional and intellectual abilities continuously for the advancement of technology

Program Learning Outcomes

- **Advanced Knowledge:** To practice mechanical engineering at an advanced level in their particular field of study
- **Problem Solving:** To apply in-depth knowledge of their chosen field in mechanical engineering using an interdisciplinary approach for problem solving

- **Research and Development:** To adapt, create, transfer, and assimilate current and emerging technologies into new products through relevant research
- **Ethics:** To understand the social and ethical responsibilities
- **Lifelong Learning:** To improve their knowledge and skills continuously for pursuing lifelong learning in the broader context of innovation and technological developments

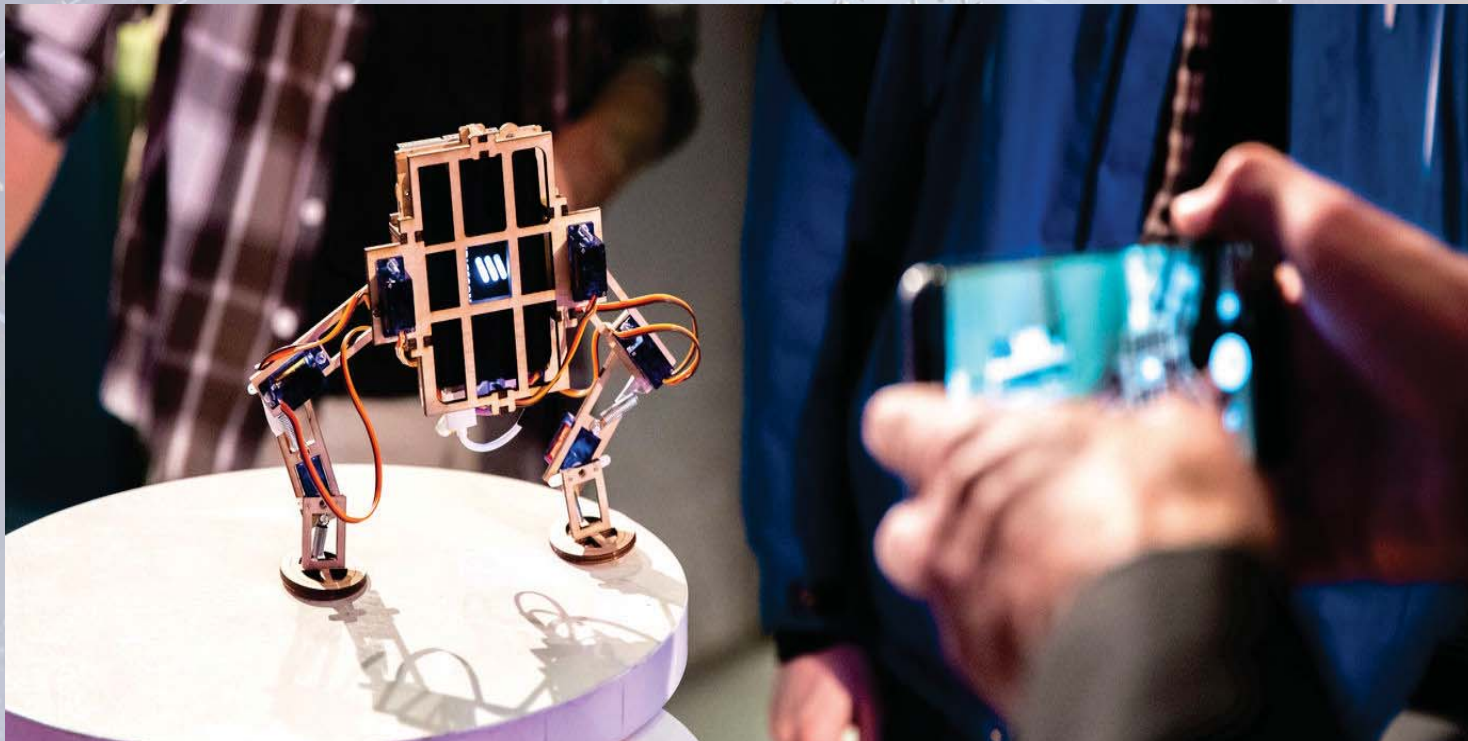

Mechanical Engineering with following specializations:

- Fluid & Thermal Systems
- Mechanical Design & Analysis
- Manufacturing Systems
- Automobile
- Dynamics & Controls

Prerequisites

- BS/ BE/ equivalent (16 Years of education) with strong background in Mechanical, Aerospace, Industrial, Manufacturing, Mechatronics, Chemical (for specialization in Fluid & Thermal Systems only), Materials Science & Engineering (for specialization in Mechanical Design & Analysis and Manufacturing Systems) with minimum CGPA ≥ 2.00 out of 4.00 or $\geq 60\%$ marks (where CGPA not available) from HEC and PEC recognized (where applicable) Institute/University or from Foreign Institute/University of good repute
- GAT-A (General) conducted by NTS in the relevant field of study with $\geq 50\%$ marks or HAT (General) conducted by HEC in the relevant field of study with $\geq 50\%$ marks or GRE International (General) conducted by ETS, USA, with minimum score as Quantitative: 145, Verbal: 145, Analytical: 3.5

The IST institutional code to receive GRE scores is 1758

Core Courses

Minimum number of credit hours of core courses are 12. The four core courses shall be taken from the area of specialization.

Elective Courses

The elective courses will be offered from the lists mentioned in each specialization subject to the availability of specialized faculty and the number of students interested in each course. An elective course can be chosen from any allied discipline as well subjected to the approval of Head of Department.

Semester	Courses	Cr. Hr.
01	Core I	03
	Core 2	03
	Elective I	03
02	Core 3	03
	Core 4	03
	Elective II	03
03	Elective III	03
	Elective IV	03
	Thesis I	03
04	Thesis II	03



Specialization in Fluid & Thermal Systems (FTS)

The specialization in fluid and thermal systems is designed to provide a practical, engineering-focused understanding of the technical challenges facing the country today. It aims to develop rational skills that can help in solving multi-disciplinary engineering problems. FTS combines the field of thermal systems and stresses, advanced combustion, fluid mechanics, heat transfer, and computational fluid dynamics, etc. to create innovative products and solutions to real-world problems. This field of specialization is quite diverse with experimental, analytical, and numerical investigations in the following areas:

- Advanced Fluid Mechanics
- Computational Fluid Dynamics
- HVAC and Refrigeration
- Thermal Systems
- Fluid Structure Interaction
- Advanced Heat Transfer and Combustion

Graduates of this program will be equipped to apply their knowledge and skills to the development of effective and environmentally friendly systems.

Core Courses

Core Courses

- Advanced Heat & Mass Transfer
- Gas Dynamics
- Advanced Fluid Mechanics
- Computational Fluid Dynamics
- Special course in Fluid Thermal System

Elective Courses

- Aircraft Engines
- Theory of Thermal Stresses
- Advanced Combustion

- HVAC and Refrigeration
- Nuclear Engineering
- Energy Conversion and Prime Movers
- Internal Combustion Engines
- Turbo Machinery
- Alternate Energy Resources
- Fluid Structure Interactions
- Vacuum Science and Technology
- Fluid Dynamics Measurements
- Total Quality Management
- Production and Operations Management
- Engineering Management and Economics
- Fluid Power and Hydraulic Machine Design
- Viscous Fluids
- Heat Transfer in Electronic Systems
- AI in Mechanical Engineering

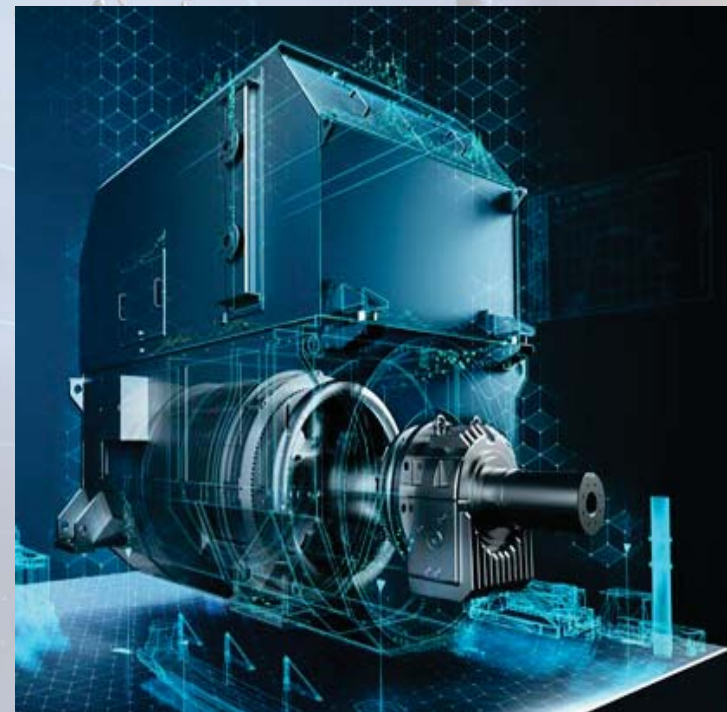

Specialization in Mechanical Design & Analysis (MDA)

Specialization in Mechanical Design and Analysis includes new methodologies for design, analysis, simulation, and experimentation of the behavior of mechanical systems and components. MDA covers several areas such as engineering design and analysis, product development, strength and dynamics of structures, modeling, simulation, and mechanics of systems with the aid of advanced mathematical tools and management techniques.

Some of the key research areas for this field of specialization are:

- Linear and Nonlinear Behavior of Mechanical Structures
- Modeling and Simulation of Mechanical Systems
- Product Design and Analysis
- Vibrations, Chaos, and Machine Condition Monitoring etc.

MDA is a valuable and pragmatic program that develops strong technical, analytical, and problem solving skills essential for a range of exciting careers in the challenging field of perfunctory engineering. This program empowers graduates to contribute to the development of new and better solutions for mechanical components and systems, production equipment, and industrial plants, etc.

Core Courses

- Mechanics of Composite Materials
- Advanced Mechanics of Materials
- Advanced Mechanical Vibrations
- Finite Element Methods
- Special course in Mechanical Design and Analysis

Elective Courses

- Advanced Heat and Mass Transfer
- Computational Fluid Dynamics

- Theory of Plates and Shells
- Product Design Fundamentals
- Renewable Energy - Fuel Cell Systems
- Theory of Plasticity
- Modeling and Simulation
- Non Destructive Evolution of Structures and Materials
- Smart Structures
- Nonlinear Dynamics and Chaos
- Rapid Prototyping
- Theory of Aero-elasticity
- Experimental Stress Analysis
- Condition Monitoring of Rotating Machines
- Introduction to MEMS
- Multidisciplinary Design Optimization
- Vibrations of Shells and Plates
- Total Quality Management
- Production and Operations Management
- Engineering Management and Economics
- Renewable and Sustainable System
- Experimental Solid Mechanics
- Energy Conversion for Sustainability
- Vortex Induced Vibrations
- AI in Mechanical Engineering
- Nano-engineering and Nano-materials

Specialization in Manufacturing Systems

Specialization in manufacturing systems combines the field of factory planning and scheduling, inventory control and queuing models, material flow and storage, optimization of production systems, forecasting, and linear and dynamic behavior of production systems for analyzing the manufacturing systems to improve the quality of products. This program allows the young engineers to assimilate systems perspectives with interdisciplinary education, combining engineering study with hands-on training, and topical research activities. The program covers not only the important aspects of manufacturing but also the business planning and management which are an essential part of the growth of industry and business. It also aims at producing quality products throughout the design process, thus focusing on integrated manufacturing and total quality management by keeping the design and production processes in parallel increasing responsiveness.

Key research areas in this specialization are as follows:

- Production Planning and Design
- Ergonomics
- Production and Operational Management
- Advanced Manufacturing Techniques
- Leadership and Entrepreneurship

The manufacturing systems program enables the graduates to implement effective manufacturing systems. Reducing high costs and improving usability, maintainability, and manufacturability are a few important areas where the department focuses on contributing and leading the ever-changing definition and role of industrial and manufacturing systems engineering.

Core Courses

- Production & Operations Management
- Advanced Manufacturing Processes
- Computer Integrated Manufacturing
- Additive Manufacturing
- Special course in Manufacturing System



Elective Courses

- Advanced Mechanics of Materials
- Supply Chain Management
- Leadership and Entrepreneurship
- Manufacturing Strategies and Technology
- Total Quality Management
- Industrial Ergonomics
- Concurrent Engineering
- Systems and Reliability Engineering
- Engineering Management and Economics
- Lean and Agile Manufacturing
- Product development
- Finite Element Methods
- Applied Optimization Techniques
- Mathematical Modeling and Simulations
- Advanced Mechanics of Materials

Specialization in Dynamics & Controls

Dynamics and Control aims to introduce the concepts of mathematical modeling, simulation, underlying forces, and control theory to measure the performance of multifaceted engineering systems. Further, it examines or improves the dynamic response with the aid of control strategies for stabilizing complex and unstable systems. Dynamics and Controls is primarily focused on combining a variety of interesting fields such as nonlinear dynamics, mechatronics, robotics, dynamics of plates and shells, rotor dynamics, control of mechanical systems, and acoustics, etc.

Specific areas of interest include:

- Nonlinear Dynamics of Physical Systems
- Application of Control Theory to Autonomous/Distributed Systems
- Space Systems and Vibrations
- Vibro-and Flow-Acoustics

Students will acquire exposure to analyzing the real dynamic systems, identify or evaluate the system parameters, stability requirements, and the control schemes to regulate them. In a nutshell, Dynamics and Controls is a multi-disciplinary area in which students will be able to model and solve the dynamical complex systems in a variety of disciplines such as mechanical, aerospace, electrical, avionics, biological, and so forth.

Core Courses

- Finite Element Methods
- Advanced Mechanical Vibrations
- Digital Control and Signal Processing
- Linear Control Systems
- Special Course in Dynamics and Controls

Elective Courses

- Mechanical Behavior of Materials
- Fracture Mechanics
- Advanced Mechanics of Materials

- Mathematical Modeling and Simulation
- Nonlinear Dynamics and Chaos
- Condition Monitoring of Rotating Machines
- Vibrations of Plates and Shells
- Rotordynamics
- Nonlinear Control Systems
- Optimal Control
- Adaptive Control
- Advanced Robotics
- Automation and Control of Mechanical Systems
- Signals and Mechanical Systems
- Vibro Acoustics
- Flow Acoustics
- AI in Mechanical Engineering
- Nano-engineering and Nano-materials

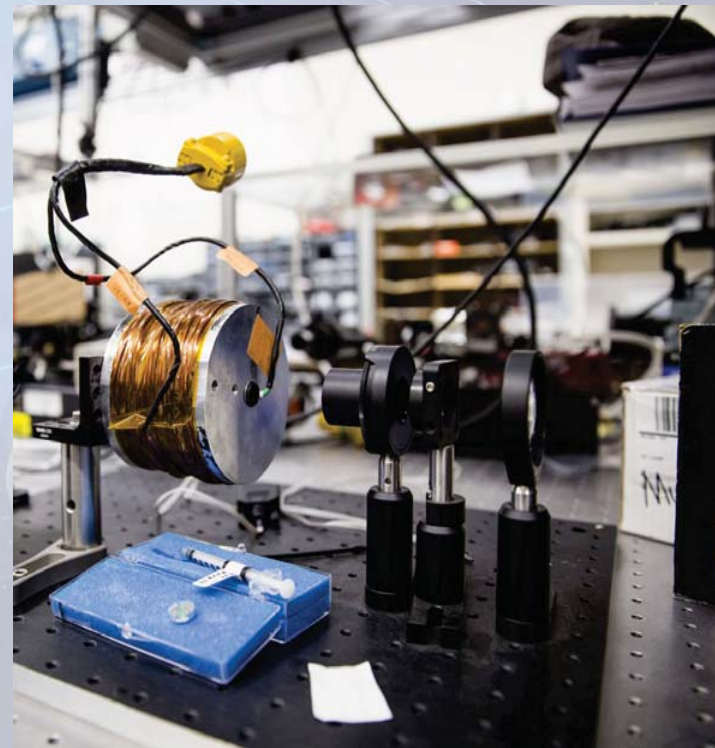

Specialization in Automobile

Specialization in Automobile deals with design and manufacturing of new vehicle and their component parts, repairing, and servicing of vehicles, integration of components into an automobile system, and the study of their sub-sections. With rapid development in modern and innovative automobile technology, young engineers broaden a comprehensive understanding of the complex field of Automobile Engineering.

The future engineers of the automobile can select one field of study out of more in the following areas:

- Vehicle Dynamics & Vibrations
- Fuel and Emission Systems
- Chassis and Power Train Systems
- Crash Safety
- Design, Manufacturing, and Assembling

This specialization provides hands-on education based on the latest scientific results and methods, that enable young engineers to work independently and with confidence. In addition, graduate students improve their social and methodical skills. The program also enables them to face ever-increasing challenges and standards of international markets.



Core Courses

- Internal Combustion Engine
- Finite Element Methods
- Introduction to Automotive Design
- Advanced CAD
- Special course in Automobile

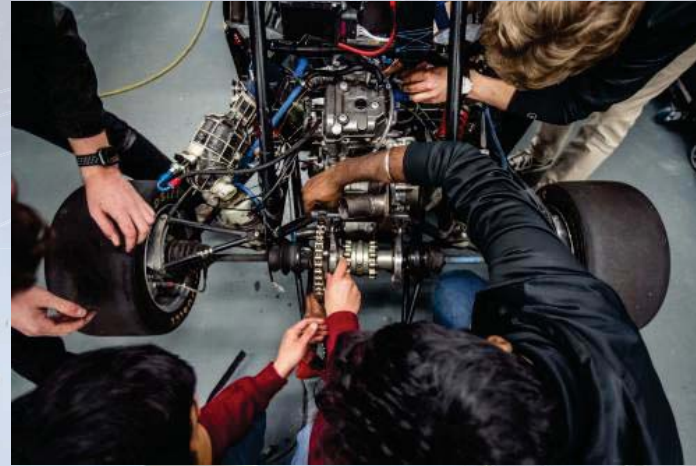

Elective Courses

- Road Vehicle Aerodynamics
- Noise Vibrations and Harshness
- Hybrid Vehicle Design
- Vehicle and Traffic Safety
- Vehicle Dynamics
- Vehicle Acoustics
- Tribology
- Production and Operations Management
- Dynamics and Controls of Automatic Transmission
- Advanced Combustion
- Chassis and Suspension design
- Power Train and Brake design

Course Description

714320 Advanced Heat and Mass Transfer (3-0)

Principles of conduction, Analysis of one-dimensional and multidimensional steady and transient, Phase change and moving heat source, Numerical and Analytical methods for solving heat conduction problems, Principles of convection, Analysis of heat transfer for internal and external flows; laminar and turbulent boundary layer theories, forced and natural convection, Analysis using similarity transformations, Integral solutions and numerical methods, Introduction to thermal radiation, Radiative exchange in semitransparent mediums, The electromagnetic spectrum; the blackbody, wave phenomena versus geometric optics, polarization, diffraction & refraction effects; emission, reflection, absorption, and transmission of thermal radiation by surfaces

714415 Advanced Fluid Mechanics (3-0)

Basic review of fluid properties and basic flow equations, laminar flows, Partial differential equations governing the conservation of mass, Momentum and energy of Newtonian fluids, Dimensional analysis for simplification of governing equations, low Reynolds number flow, high Reynolds number laminar flow, Boundary layer

separation phenomena and approximations to the governing equations, laminar stability and transition to turbulent boundary layer conditions



715213 Computational Fluid Dynamics (3-0)

Numerical methods or the basic equations of fluid dynamics, Navier-Stokes equations, Euler and Reynolds averaged equations governing the flow of gases and liquids, Turbulence models, Basics of finite approximations for partial differential equations, Mathematical properties of hyperbolic systems, Finite volume and finite element methods, Boundary conditions, Grid generation Classification, implicit & explicit methods, iterative & time/space marching schemes, grids, boundary conditions, Classification of partial differential equations and solution techniques. Truncation errors, stability, conservation, differencing strategies. Advanced solution algorithms, Grid generation and Practical algorithms for compressible and incompressible flow, Introduction to verification, Validation, and uncertainty quantification for

computational fluid dynamics predictions, Practicing modules on commercial software ANSYS / COMSOL MULTIPHYSICS

714330 Internal Combustion (IC) Engines (3-0)

Thermodynamic Analysis of IC Engine Cycles, Effect of design and operating parameters on cycle efficiency, Modified fuel-air cycle considering heat losses and valve timing, Engine dynamics and torque analysis, Use of Combustion chart, Thermodynamic cycle with supercharging both Spark ignition(SI) and CI Engines, Limits of Supercharging, Methods of Supercharging and Superchargers, Fuels and combustion in SI engines, knocking and fuel rating, Energy balance, volumetric efficiency, measurement of indicated and brake power, Advanced theory of carburetion, Fuel Injection Systems for Spark ignition(SI) and CI Engines, Cooling and governing of engine, Ignition system, Variable compression ratio engine, Theoretical analysis, methods of obtaining variable compression ratio, Stratified charged engine, Methods of charge stratification,



Dual fuel and Multi-fuel engines, Biofuels, Variable Valve timing engines, Exhaust emissions and its measurement and control, Fault diagnosis of SI Engines

714331 Design of Thermal Systems (3-0)

Modeling of Thermal Systems: types of models, Mathematical modeling, Curve fitting, Linear algebraic systems, Numerical model for a system, System simulation, Methods for numerical simulation
 Design of a Thermal System: initial design, design strategies, design of systems for different applications, additional considerations for large practical systems; Economic Considerations: calculation of interest, worth of money as a function of time, series of payments, raising capital, taxes, economic factor in design, application to thermal systems. Problem Formulation for optimization, optimization methods, optimization of thermal systems, practical aspects in optimal design, Lagrange multipliers, Optimization of constrained and unconstrained problems, Applicability to thermal systems; search methods: single-variable problem, multivariable constrained optimization, examples of thermal systems, geometric, linear, and dynamic programming and other methods for optimization, knowledge-based design and additional considerations

714332 Theory of Thermal Stresses (3-0)

Effects of thermal environment on people and the means of assessing and controlling risks associated with thermal stress, thermal spectrum, Principles, Effects of temperature extremes, Thermal comfort, Evaluation of hot environments, Control of hot environments, Thermal surveys, Evaluation of cold environments, Control of cold environments and Approaches to Risk Assessment

714333 Advanced Thermodynamics (3-0)

Introduction to basic Thermodynamics, Statistical Thermodynamics, Dynamics of Non equilibrium Processes, Flux Equations, Entropy Production Minimization Theory, Fluid Equations, Simple Kinetic Theoretical Estimates, Distribution Functions & the Transport Equation, Collisional Processes, Moments of the Transport Equation, Chapman-Enskog Method

714326 Advanced Combustion (3-0)

Fuels and types, combustion process, combustion mechanism, adiabatic flame temperature, flame propagation, stability, kinetics, combustion aerodynamics, gaseous detonations, flame ignition and extinction and condensed phase combustion, combustion in SI and CI engines, ignition and burning rate

analysis. Solid burning equipment, stokers, pulverized coal burning systems, cyclone combustors, emissions, types of fluidized beds, fluidized bed combustion, fundamentals bubbling bed, gas and liquid burners types, gas turbine combustion systems, combustion modeling, Design of combustion systems for boilers, furnaces, gas turbines and IC engines, combustion chamber performance. Propellants Types, theory of combustion, energy balance calculations

705414 Aircraft Engines (3-0)

Introduction to modern aircraft engines, Classification of aircraft engines, Brayton Cycle and its applications, Component of Jet engines, Parametric Cycle Analysis (turbojets, turbofans, turboprops and ramjet engines), Component Performance, Irreversibility of each component and Engine Performance Analysis

714328 Thermal Design of Heat Exchanger (3-0)

Procedure for designing industrial heat exchangers, Introduction of classes of heat exchangers, Mechanisms of heat transfer, Basic theory of heat exchangers, Selection of heat exchangers, Double-pipe heat exchanger, Shell-and-tube heat exchangers, Plate-fin heat exchangers

714329 HVAC & Refrigeration (3-0)

Introduction to air conditioning systems and refrigeration applications, heat pumps, air handling units, air conditioning systems, applied psychometrics, design principles, and comfort in the built environment, cooling load calculations, heating load calculations, introduction and use of computer-based load estimation packages software, air distribution, fans, ducts, air conditioning controls, advanced refrigeration cycles, evaporators, condensers, cooling towers, compressors, pumps, throttling devices, piping, refrigerants, control, refrigeration equipment, simulation of refrigeration systems, refrigeration and industrial applications

711128 Nuclear Power Plants (3-0)

Basic concepts of reactor physics, radioactivity, Neutron Scattering, Thermal and fast reactors, Nuclear cross-sections, Neutron flux and reaction rates, Moderator criteria. Reactor core design, Conversion breeding and Types of reactors, Operations of Nuclear Power Plants, Characteristics of boiling water, Pressurized water, Pressurized heavy water, Gas cooled and liquid metal cooled reactors, Future trends in reactor design and operation, Thermal-hydraulics of reactors, Heavy water management,

Containment system for nuclear reactor, Reactor safety radiation shields, Waste management and Pakistan nuclear power program

715002 Energy Conversion & Prime Movers (3-0)

Understanding of the theory, technology, and practice of converting energy into useful forms, Different type of prime movers, Steam turbine, Steam Turbine Modeling, Speed Governors for Steam Turbines, Diesel Engines, Stirling Engines, Hydraulic Turbines, Wind turbine

714408 Turbo Machinery (3-0)

Introduction and overview of the design and performance of all types of Turbo machines, The essential elements of axial & radial turbo machinery design and performance, Fundamental principles of fluid mechanics, thermo-dynamics, and structural mechanics, all of the essential turbo machinery concepts, Sound understanding of the basic principles which govern the flow through any turbine, Pump, compressor, or fan together with failure mechanisms and life prediction methods

714405 Gas Dynamics (3-0)

Intro to basic Fluid and Thermodynamic Principles, Normal Shock Waves, Oblique Shock Waves, Prandtl-Meyer Expansions and

Applications, Generalized One Dimensional Flow, Isentropic Flow with Area Change, Fanno Flow, Rayleigh Flow, Supersonic Flow, Method of Characteristics (Application to One-Dimensional Unsteady Isentropic Flow)

715003 Alternate Energy Resources (3-0)

Energy scenario and renewable energy sources, Potential of non-conventional energy sources, economics, Solar Radiation: Solar thermal process, Heat transfer devices, solar radiation measurement, estimation of average solar radiation. Solar energy storage: stratified storage, well mixed storage, comparison, Hot water system, practical consideration, solar ponds, Non-convective solar pond, extraction of thermal energy and application of solar ponds, Wind energy: The nature of wind, Wind energy resources and modeling, Geothermal energy: Origin and types of geothermal energy and utilization, Ocean Thermal Energy Conversion(OTEC): Ocean temperature differences. OTEC systems. Recent OTEC developments. Wave energy: Fundamentals, Availability, Wave-energy conversion systems, Tidal energy: Fundamentals. Availability, Energy from biomass: Photosynthesis, Biomass resource, Utilization of biomass

714412 Fluid Structure Interactions (3-0)

The course will focus on the fundamental concepts and advanced topics in computational fluid-structure interaction (FSI). Introduction to important techniques to solve fluid-structure interaction problems, the stabilized formulations, Arbitrary Lagrangian-Eulerian (ALE) method, space-time (ST) method, mesh update methods for flows with moving interfaces, iterative solution techniques and parallel computing concepts, and iso-geometric analysis. ST computational FSI techniques and FSI coupling techniques. The core technologies and the special techniques targeting specific classes of problems, solution techniques to tackle common difficulties in fluid-structure interaction simulations

14414 Fluid Dynamics Measurements (3-0)

Dimensional analysis and similtude, Uncertainty analysis, pressure measurement techniques, Flow visualization techniques, Flow measurement, Force measurement, Digital data acquisition and time series analysis

Heat Transfer in Electronic Systems (3-0)

Thermal management of electronics, Preventions of heat related in electronics, Thermal design process, Macroscopic and microscopic

energies, Fins and heat sinks, Computer simulation and thermal design, Thermal interface materials, Thermoelectric coolers, Advanced cooling techniques, Circuit boards and hybrid circuit, Heat pipes, Liquid cooling, Electro hydrodynamic flow, Intelligent thermal design to prevent heat-related failures

Viscous Fluids (3-0)

Some examples of viscous flow phenomena, properties of fluids; Boundary conditions, Equation of continuity, the Navier stokes equations, the Energy equation; boundary conditions, Orthogonal coordinate systems; dimensionless parameters, velocity considerations, two dimensional considerations, and the stream functions, Couette flows; Poiseulle flow, Unsteady solution from the papers, Introduction to laminar boundary layers equations and similarity solutions, Two dimensional solutions; Thermal boundary layer, Some exposure will also be given from the recent literature appearing in the journals.

Fluid Power and Hydraulic Design (3-0)

Hydraulic Fluids and Lubes, Hydraulic Pumps, Hydraulic Valves and Circuits, Hydraulic Cylinders and Actuators, Hydraulic Motors, Couplings, Drives, Fluid Shock Absorbers and Accumulators Hydraulic Flow, Pressure Drop, Response, H hydraulic Applications, Pneumatic Systems and

Components, Rotary Seals: Mechanical, Labyrinth, Magnetic, Self-Pumping

711119 Mechanical Behavior of Materials (3-0)

Types of stresses & strains, elastic & plastic deformation, Defects & Imperfections in single poly-crystalline materials, Classification of defects, Tensile, Compressive, Torsion, Impact & Fracture, Effect of strain rate on flow properties of materials, fracture mechanics, fatigue, creep and stress rupture of materials, Griffith & Orwan theory of fracture of materials, Nabaro-Herring and coble creep, materials selection and failure analysis, Case studies

714808 Finite Element Methods (3-0)

Introduction to Finite Element Methods (FEM), Mathematical preliminaries, Strong and weak form of FEM, Truss Analysis, Variational approaches & weighted residual formulations to FEM, General approach to structure analysis, cn continuous shape functions, Stress analysis for one & two-dimensional problems of structures, problem formulation and solution for 1D, 2D, 3D, in-Plane and Eigen value problems, beam analysis, introduction to coupled problems in FEM, Dynamical Structural Analysis and ANSYS / COMSOL MULTIPHYSICS for analysis

714212 Advanced Mechanics of Materials (3-0)

Introduction, Stress and Strain based analysis, Failure criteria for thick cylinders, Unsymmetrical Bending, Cauchy Elastic Materials, Failure Theories, Damage Mechanics, Viscoelasticity, Intro to Continuum Mechanics, Fracture Mechanics, Composite Materials, categorization based on elastic and plastic behavior of materials, problem formulation for linear elasticity, Variational formulation, Energy theorems, Hamiltonian formulations and introduction to thermo-elasticity and viscoelasticity

714606 Advanced Mechanical Vibrations (3-0)

Fundamentals of the theory of surfaces, Kirchhoff Hypotheses, Fundamental equations of the classical plate theory, symmetrical bending of circular plates, bending of rectangular plates, anisotropic plates and plates of various shapes, Navier's solution and Levy's method for rectangular plates, special and approximate methods in theory of plates and shells, thermal stresses in plates, theory of edge effect, buckling, membrane theory of shells, bending theory of axi-symmetrically loaded circular cylindrical shells

714704 Fracture Mechanics (3-0)

Basic concepts, Toughness, elastic & plastic fracture mechanics, Fatigue,

creep, and Impact fracture behavior, fracture mechanism in metals and non-metals, crack propagation, thermal fatigue

714237 Theory of Plates and Shells (3-0)

Free and forced vibration of single-degree-of-freedom, two-degree-of-freedom and multiple-degree-of-freedom systems, determination of natural frequencies, experimental modal analysis, and mode shapes Transient vibrations, Analytical methods to solve dynamic systems, Eigen problems, continuous systems and their modeling, damping, vibration design and control

714517 Product Design Fundamentals (3-0)

Optimization methods, nonlinear optimization under constraints, multi objective optimization, multidisciplinary design, incorporating different disciplines simultaneously, single and multi-objective optimization under constraints, Different approaches to Multidisciplinary Design

714218 Theory of Plasticity (3-0)

Fundamentals of plasticity, Stress-Strain curve, Yield Criteria, isotropy, anisotropy, small deformation and rate independence. Plastic analysis in beams and frames, elasto-plastic bending and torsion, theory of slip-line field, Slip-line field theory for plane

strain elastically rigid perfectly plastic solids, plane strain and axis symmetric loading, Metal forming

714230 Theory of Elasticity (3-0)

Basic definitions of stress and strain tensors, Stress strain curve, Hook's Law, Stiffness and Modulus of Elasticity, Strain - deformation relations for small deformations, Equilibrium equations, Analysis of properties for isotropic, orthotropic and anisotropic materials, Airy stress functions for 2D plane stress and plane strain

711120 Mechanics of Composite Materials (3-0)

Types of Composites, manufacturing, mathematical modeling for composites, laminated – unidirectional composites under various loading conditions, lamination theory, effective stiffness properties, laminated plate theory, edge effects in laminates, nonlinear theory of composites, failure theories of composites, behavior of composites under fatigue, creep, bending, and impact

Rotordynamics (3-0)

Rotor Modeling Techniques, Rotating Machines Bearings and supports, Torsional Vibrations Dynamics, Rotor dynamics of Geared Systems, Reduced Order Modeling in Rotor Dynamics, synchronous and non-synchronous whirl, sensitivity to

unbalance, threshold of instability, torsional behavior of rotary machines, the analysis of steady and cyclic stress distributions caused by unbalance and other vibration phenomena

714709 Non-destructive evolution of Structures and Materials (3-0)

Realization of the full potential of structures, The course aims to introduce the full range of Non-destructive evolution(NDE) techniques currently available, including ultrasonic's, low-frequency methods, X-radiography, acoustic emission, shear graph, and thermograph

Flow Induced Vibrations (3-0)

Body Oscillators, Dimensional Analysis, Ideal Fluid Models, Vortex Induced Vibrations, Galloping and Flutter, Instability of Tubes and Cylinder Arrays, Vibrations Induced due to Oscillatory flow, Inline forces and Motion, Fluid Force coefficients, Transverse Force and Response Reduction of Vibration Induced by Oscillating Flow

714218 Smart Structures (3-0)

Adaptive structures theory and design, actuation system, shape memory alloys, piezoelectric materials, composite skins and elastic sheets, anemometer, thermocouple, pitot tube, magnetostrictor, electrostriction, fiber optic sensors, Feedback smart structures

714603 Nonlinear Dynamics and Chaos (3-0)

Modeling of Duffing type Mathieu systems, sources of geometrically non-linearity, kinematics and rigid body dynamics, non dimensionalization of equation of motion, methods of harmonic balance, simple perturbations, review of Floquet theory, chaotic dynamics, chaotic vibrations

714236 Theory of Aero-elasticity (3-0)

Theory of Elasticity, Basic Aerodynamics and Aerodynamic analysis tools, structural dynamics (Single and Multi degree of freedom systems), Complex Analysis, derivation of equations of elasticity, Problems in Plane stress and plane strain, Fourier transformation, basic review of control systems, steady and unsteady aerodynamics, Static Aero elasticity phenomena (Divergence, loss of lift effectiveness and control reversal, Aero-elastic trim), St. Venant's Principle, various solutions for different plate profiles, numerical energy method, unsteady aerodynamics, dynamic aero-elasticity (Flutter, Dynamic response (gust)), roto-dynamics (wind turbines, hydropower turbines and jet engines)

714707 Experimental Stress Analysis (3-0)

Revision of Fundamental concepts of stress and strain in two and three dimension, Mechanical and electrical gauges, Electrical resistance strain

gage material, Foil and wire gages, Two and three elements rosette, Cross sensitivity factor, Potentiometer and Wheatstone bridge circuit, Full-half and quarter bridge circuit, Strain indicators, Data acquisition systems, Transducers, Optics description of light as an electromagnetic wave. Maxwell's equations, Design of optical elements, Wave plates, Theory of diffraction of light, Stress optic law, Photo-elasticity. Caustics, Stress Freezing, Scattered ray and brittle coating techniques, Grid methods, Study of Dynamic stress-strain curve, Dynamic Stress analysis of materials

714604 Condition Monitoring of Rotating Machines (3-0)

Introduction to vibration analysis, maintenance in modern industry, machine condition indicators, use of vibration of mechanical components on machine condition indicators, common causes of vibrations in mechanical system, vibration characteristics, spectrum analysis, vibration orbits or LISSAJOUS figure, statistical distribution of the common causes of vibration, Lubricant analysis, spectral changes, signature analysis

708308 Introduction to MEMS (3-0)

Introduction to Microsystems, overview and trends, MEMS materials, Lithography & thin film processes, Bulk silicon

micromachining, Surface micromachining, MEMS design, Electrostatics, Electromagnetic, thermal actuation, Inertial sensors; Accelerometer, Gyroscope, pressure transducers, Optical transducers, Microfluidic basics, Microfluidic devices, bio-MEMS, MEMS packages, Application of MEMS in space satellites

714710 Fatigue in Metals & Composites (3-0)

Intro to fatigue in metals & composites, Fatigue crack growth, Structural integrity of Metals, Structural Integrity Polymeric matrix composite laminates, Biomaterials and its applications

714605 Vibrations of shells & Plates (3-0)

Intro to Vibrations of Shells and Plates, Deep shell Equations, Equation of Motions for commonly occurring geometries, Non shell structures, natural frequencies & Modes, vibrations of shells and Membranes under the influence of initial stresses, Combination of Structures and its applications

Experimental Solid Mechanics (3-0)

Principles and methods of mechanical testing, stress and strain analysis under monotonic and cyclic loading, strain measurements through strain gauges, Fatigue behavior and fracture involving life

prediction and prevention of failure. Experimentation and theory verification, including planning, testing, and data analysis with report preparation.

Multidisciplinary Design Optimization (3-0)

Optimal design problem formulation, Unconstrained and constrained functions in N-variables, Linear Programming, Sequential unconstrained minimization techniques, Global optimization, Multiobjective optimization.

Renewable and Sustainable Energy System (3-0)

Alternative energy systems, Corporate and organizational sustainability, Energy efficiency software applications, Energy evaluations, Energy for sustainable development, Energy modeling software and applications, Environmental impacts or renewable energy sources, Renewable energy return of investments, Solar Energy, Wind energy conversion

714506 Advanced Manufacturing Systems & Design (3-0)

Introduction to Automation and Control Technologies, Industrial Control Systems, Sensors, Actuators and other control components, Numerical Control, Industrial Robotics, CIM, Material Transport Systems (Industrial Trucks, AGVs,

Monorails), Automated Storage Systems, Flexible Manufacturing Systems, Automated Assembly Systems, Intelligent Manufacturing Systems, Lean Manufacturing, Just-in-time(JIT) Production, Process Planning and Concurrent Engineering

714505 Advanced Manufacturing Processes (3-0)

Introduction, Advanced casting processes, Advanced Welding Techniques, Laser Technology, Composites Manufacturing, Glass Technology, Rapid Prototyping, Design for Manufacturing & Assembly, Concurrent Engineering, Heat Treatment, Non-Traditional Cutting Techniques, Intro to Nanotechnology

714813 Applied Optimization Techniques (3-0)

Optimization Areas & Introduction, Direct and indirect approach, Gradient based methods, Global and local methods, Lagrangian approach, Convexity, KKT conditions, Region elimination methods, Linear Programming, Conjugate gradient methods, Advanced Optimization Techniques, Evolutionary Approach Genetic Algorithms, Application areas and Modeling Methods

714508 Computer Integrated Manufacturing (CIM) (3-0)

Introduction to CIM, CIM Wheel & Jigsaw, PLC & CNC programming as

automated inspection and transportation systems, Open Systems & Standardization, Open Networks, IDEF Modeling Methods, House of Quality tool, Lean Manufacturing and other artificial intelligence technologies, Training on CAD/CAM software like Pro-E / Creo2 / Master CAM Mill 8+ / DELCAM / Part Maker etc

700404 Supply Chain Management (3-0)

Quantitative Analysis, Financial Management, Managing Accounting Information for Decision Making, Operations Management, Project Management, Supply Chain Overview, Enterprise Operations & Planning

700210 Leadership & Entrepreneurship (3-0)

Introduction, Entrepreneurship, Entrepreneur Forum, Entrepreneurial Traits, Small & Medium scale industries, Entrepreneurial Ethics, Business Plans, Marketing for small business, Franchising, Case Studies

714516 Manufacturing Strategies & Technology (3-0)

Methodologies used in the synthesis and analysis of product design to optimize manufacturability, Relationship of design to production processes, product material, material handling, quality costs, and CAD/CAM, Introduction to cloud Manufacturing, Rapid Prototyping, CNC programming

715217 Modeling & Simulation (3-0)

Stochastic processes applied to control of various types of systems: Markov chains, Queuing theory, Bifurcations, Perturbation Methods, non-homogeneous Equations, Modeling and Simulation of Dynamic systems based on Bond graph theory, Training on Lab-View software

714518 Product Development (3-0)

Introduction, Product Development Strategies, Idea Generation & Screening, Concept Development & Testing, State-gate Process, Commercialization, Product Development Principles, Batch & Mass Manufacture, Facility Designing & Management

700407 Total Quality Management (3-0)

Management of Quality Assurance, Operational and Statistical Principles of Acceptance Sampling and Process Control, Quality problems in production lines, Introduction to Total Quality Management concepts, Taguchi Methods, Quality Function Deployment, ISO 9000 & Baldrige Award

700403 Production & Operations Management (3-0)

Methods of Planning and Control of Manufacturing Organization, Processes and Facilities including

Demand forecasting, Product Development, Capacity Planning, Inventory Control, Site selection, Finance Development, Decision Processes, Personnel Development and Training, Manufacturing Policy Formulation, Sequencing & Scheduling

715103 Industrial Ergonomics (3-0)

Functional Anatomy of the Human body, Work physiology and body Energy Expenditure, Biomechanics for people at work, Analytical tools for Ergonomics, Introduction of the fundamentals and applications of industrial ergonomics for improving equipment & tools, workplace & job design, Design principles for human operators and current issues in industrial ergonomics, Evaluating methodologies for design

714509 Concurrent Engineering (3-0)

Concurrent/simultaneous engineering methods and tools such as system analysis, modeling and Integration, Market Oriented, Integrated Design for Manufacturing, Assembly, Quality and Maintenance, Product Design Analysis, Integrated Product Design and Manufacturing innovation methods, QFD (Quality Function Deployment) applied to concurrent engineering, FMEA (Failure Mode and Effect Analysis), POKA-YOKE, KANZEI, waste reduction, quality circles, Rapid Prototyping of designed objects

714523 Systems and Reliability Engineering (3-0)

Reliability Theory, Basic concepts of Probability, Poisson Process Models, Reliability in Product and Process Development, Reliability Model & Predictions, Statistical Inference, Reliability Design Techniques, Design of Experiments, Reliability Program Management, Fault Avoidance, Software Testing, Product Testing, Redundancy & Fault Tolerance

700402 Engineering Management & Economics (3-0)

Organization Structure, Project Delivery Systems, Planning & Scheduling, Cost Control, Uncertainty Analysis in Engineering, Random Signals, Time Value of Money, Interest Equivalence, Evaluation of Projects, Inflation, Depreciation, Taxation

Rapid Prototyping (3-0)

History and Overview of Rapid Prototyping, General Usage of Rapid Prototyping, Data Translations (Cad to Rapid), File Format (STL - Stereolithography), Operation of Rapid Prototyping Machine, Exposure to CAD/CAM as it relates to RP, History and Overview of Reverse Engineering, General Usage of Reverse Engineering, Input Data (Stream, Point clouds, etc.) General Operation of Reverse Engineering equipment (3D Scanners, Articulating Arms, and 3D Digital Cameras), Manipulation and Editing of STL data (triangulated meshes)

Applied Optimization Techniques (3-0)

Unconstrained optimization, Nonlinear constrained optimization Stochastic Optimization Mixed-integer optimization

Mathematical Modeling and Simulation (3-0)

Introduction: System, environment, input and output variables, State variables; Static and Dynamic systems; Hierarchy of knowledge about a system and Modeling Strategy, Physical Modeling: Dimensions analysis, Dimensionless grouping of input and output variables of find empirical relations, similarity criteria and their application to physical models, Modeling of System with Known Structure: Review of conservation laws and the governing equation for heat, mass and momentum transfer, Deterministic model-(a) distributed parameter models in terms of partial identification and their solutions and (b) lumped parameter models in terms of differential and difference equations, state space model, transfer functions block diagram and sub systems, stability of transfer functions, modeling for control, Optimizations and Design of Systems: Summary of gradient based techniques: Nontraditional Optimizations techniques (1) genetic Algorithm (GA)- coding, GA operations elitism, Application using MATLAB:(ii) Simulated Annealing Neural Network Modeling of Systems

only with Input-output Database: Neurons, architecture of neural networks, knowledge representation, learning algorithm. Multilayer feed forward network and its back propagation learning algorithm, Application to complex engineering systems and strategy for optimum output, Modeling Based on Expert Knowledge: Fuzzy sets, Membership functions, Fuzzy Inference systems, Expert Knowledge and Fuzzy Models, Design of Fuzzy Controllers, Simulation of Engineering Systems: Monte-Carlo simulation, Simulation of continuous and discrete processes with suitable examples from engineering problems.

Digital Control and Signals Processing (3-0)

Review of continuous control, digital control engineering, discrete systems analysis, sampled- data system, design of digital control systems using transform techniques, state-space method, digital filters.

Linear Control Systems (3-0)

Mathematical description of systems, basics of linear algebra, state-space solutions and realizations, stability, controllability, observability, state feedback and state estimators.

Nonlinear Control Systems (3-0)

Phase plane analysis, fundamentals of Lyapunov theory, advanced stability theory, feedback linearization- Intuitive concepts, mathematical

tools, Input/output-state linearization, sliding control and robust control.

Adaptive Control (3-0)

Model reference adaptive control, output/input error method, self-tuning regulator, Lyapunov stability, Identification of continuous- and discrete-time systems, robustness analysis, adaptive control of discrete-time systems.

Optimal Control (3-0)

Static optimization, nonlinear optimal control of discrete and continuous systems, linear quadratic control, manipulating stochastic signals, Optimal state estimation (Kalman filter theory), linear quadratic Gaussian control.

Advanced Robotics (3-0)

Robotic arm forward and reverse kinematics, robot arm dynamics, trajectory planning, sensors and actuators of robot manipulators, motion control, sensing mechanism

Automation and Control of Mechanical System (3-0)

Mechanical and interconvertible systems (electrical, fluidics), hydraulics systems control, pneumatic systems control, sequential operation using programmable logic, applications of relays/switches, transducers, feedback control systems, programmable controllers, automatic orientation and assembly

Signals and Mechanical System (3-0)

Classification of signals, amplitude characterization, Fourier analysis, Laplace transforms in signal analysis, discrete signals (sampling, averaging, correlation methods), linear systems, frequency response functions, power spectral density, z-transforms, filter design (continuous and discrete, control of mechanical systems, machine monitoring, active control of sound and vibration, statistical signal processing.

714901 Introduction to Automotive Design (3-0)

Vehicle mechanics, Introduction to automotive layout configurations, modeling philosophy, Automotive design elements: Powertrain, Braking, Suspension, Styling, Chassis, interior design and ergonomics, Road surfaces and tyre-ground interaction Axle loads, Road loads: Aerodynamically induced forces and moments Aerodynamic vehicle design Quasi-static cornering behavior. Acceleration behavior: Powertrain elements and their characteristics, Traction and power limited performance Fuel economy. Deceleration behavior: Brake system components and their characteristics, Brake proportioning, efficiency and adhesion utilization, Governing standards and legislation. Handling behavior, handling performance criteria,

mathematical modeling of vehicle handling, straight line stability and cornering behavior, Practical suspension system design

715214 Advanced Computer Aided Design (3-0)

CAD philosophy, Part Modeling through constructive solid geometry, engineering drawings, and interfacing with CNC machines, assembly drawing, mechanical joints and fasteners modeling, surfacing and styling.

714910 Vehicle and Traffic Safety (3-0)

History of crash safety, Active and Passive safety, Road design for safety, restraint and supplemental restraint systems, crumple zones and structural design, fire and post-crash safety, Crash legislation and testing in various parts of the world, evolution of crash safety protocols, application of crash safety practices in Pakistan, Statistical data collection and interpretation, Design constraints for crash, Computational methods to analyze the mechanical response of automotive structure, Systems and components to dynamic impact loading such as in crash situations, Crush characteristics, Structural collapse and their influence on safety, Social and economic aspects of safety

714905 Powertrain and Brake Design (3-0)

Introduction: Overview of powertrain components and systems. Clutch: Torque capacity, performance during engagement process, thermal analysis. Transmission: Manual and automatic gearboxes, synchronisers, continuously variable transmissions, traction control. Belt drive: Power transmission, efficiency, synchronous belts. Brakes: Designs, torque calculations, noise and vibration, anti-lock braking systems, thermal analysis. Drivetrain Noise Vibration harshness(NVH): Approaches to dynamic system modelling, performance and refinement issues

714906 Chassis and Suspension Design (3-0)

Suspension systems and components: Introduction to vehicle suspensions, suspension types, suspension components and their characteristics, design and selection-springs, anti-roll bars, dampers, bushes, kinematic and force analysis, anti-squat and anti-jounce geometries, vehicle ride quality analysis. Steering systems: review of designs, system geometry and kinematics, bump, roll and compliance steer, forces-stationary and moving vehicles, four wheel steer. NVH: fundamentals of acoustics, subjective response to noise, automotive vibration-sources, modelling and control, automotive noise-sources, criteria and control.

Chassis structure: review of vehicle structures, analysis of car body structures, and safety under impact, Acoustics and human comfort, analytical and numerical analysis

714907 Road Vehicle Aerodynamics (3-0)

Numerical methods or the basic equations of fluid dynamics, Navier-Stokes equations, Euler and Reynolds Averaged equations, Turbulence models, Basics of finite approximations for partial differential equations, Mathematical properties of hyperbolic systems, Finite volume and finite element methods, Boundary conditions, Grid generation and Practical algorithms for compressible and incompressible flow

714908 Noise Vibrations and Harshness (3-0)

The application of engineering tools and specifications for noise, vibrations, and harshness, Sources, Mitigation methods, Complexity and influences on other vehicle functions, Design, simulation and validation methods

714909 Hybrid Vehicle Design (3-0)

The course focuses on techniques and tools to build Hardware-in-the-Loop (HIL) Simulation for evaluating hybrid powertrains components and architectures using programmable power supplies, electrical loads, dynamometers, and rapid control

prototyping tools. Special emphasis is given to the use of such tools for component characterization, safely and efficiently interfacing electric machines and their controllers within the hybrid powertrain, accommodating accessory loads (disturbances) in hybrid powertrains and conducting system diagnostics

714911 Vehicle Dynamics (3-0)

Vehicle ride, Quarter/half/full car model, Suspension design optimization, Design guidelines/conflicts, Wheelbase effects and left/right track inputs, Front/Rear suspension results, Ride measurements, Human response to vibration, ISO standards, Springs, nonlinear effects, bump stops, Damper properties, nonlinear properties, mono-tube, twin-tube. Vehicle handling: Development of 2-degree of freedom(DOF) model, Understeer/Oversteer, Steady state cornering, stability, frequency response, Transient, limiting manoeuvres, Standard tests, steering pad, J turn, Lane change manoeuvres, Straight running, stability, aerodynamics effects, neutral steer point, Effects of braking, traction, Effect of vehicle/suspension design properties, c.g. position, tyre size, load transfer, camber, compliances, Effects of braking, traction, Extended model including roll, steering system, suspension derivatives. Tyres: Mechanism of

force generation, Study of typical force/moment data, Review of tyre models. Suspension kinematics and compliances: Role of the suspension, Kinematics, wheel motion control, Forces transmitted, Roll centres, anti-dive and anti-squat properties, Suspension design, Review of typical designs, Current design trends, Practical implications

714903 Vehicle Acoustics (3-0)

Review of current methods for the noise, vibration and harshness (NVH) design of passenger vehicles. Load cases, analysis types and CAE (Computer Aided Engineering) optimization processes. NVH analysis with relationship to other vehicle function CAE processes, Modeling, analysis procedures and accuracy of results in “virtual” vehicle development process. Variability in actual vehicle structures, Materials, modeling and design, for NVH treatment, Sound quality, Source identification

714904 Dynamics and Controls of Automatic Transmissions (3-0)

Vibration fundamentals, Vibration of multi degree-of-freedom systems, Automotive Engine Vibration, Automotive Driveline Torsion Vibrations, Finite Element Method in Vibration Analysis

714711 Tribology (3-0)

Surface topography and contact mechanics, Hydrodynamic, Elasto-Hydrodynamic and Boundary lubrication, Rheology and lubricant chemistry, Wear and friction of metals, Ceramics and Polymers, Surface Engineering, Delamination theory, Test methods in Tribology

AI in Mechanical Engineering (3-0)

Introduction to machine learning, Data visualization, Similarity, norms, and feature engineering, Supervised learning, Cross validation, unsupervised learning, Dimensionality reduction, Neural networks, Self-supervised learning, Deep generative models, Robotics and automation with AI, AI in manufacturing and process optimization, Computational creativity and novelty detection, Natural language processing introduction, and Challenges in data-driven design applications

Nano-engineering and Nano-materials (3-0)

Introduction to advanced nanotechnology, advanced nanomaterials, Nanoscale fabrication techniques, Applied nanomaterial characterization, Advanced Nano mechanics, Nanotechnology in advanced engineering applications, Nanotechnology research and future trends

(899903,899904) Thesis

Individual projects are carried out under the supervision of one or more members of academia. It requires literature review, investigating problems, testing, data gathering and analysis, modelling and development, experimentation, and evaluation of results. These various aspects vary from study to study; however, the maximum components must be a part of the studies



PhD in Mechanical Engineering

The Ph.D. program at the Department of Mechanical Engineering creates professionals who can contribute valuably to society through high-quality research. The program's uniqueness lies in inculcating critical thinking, exploring innovative solutions, and applying a multidisciplinary approach to solve problems related to industrial needs. The department has state-of-the-art advanced laboratories established with the vision to enhance research and development activities in the field of mechanical engineering and its allied disciplines. The department has well-qualified Faculty which is actively involved in research and development in the areas of Fluid Mechanics, Solid Mechanics, Vibrations, Energy, Materials, and Manufacturing. The Ph.D. is a full-time program, in which students complete their related course work, pass their qualifying exams, write a thesis, and publish their work in reputable international journals and conferences.

Program Educational Objectives

- Apply advanced knowledge and methodological skills to conduct independent and original research in mechanical and allied disciplines
- Demonstrates the traits to recognize social and ethical standards

- Enhance their professional and intellectual abilities continuously for the advancement of technology

Program Learning Outcomes

- **Advancement of Knowledge:** To practice mechanical engineering at an advanced level in their particular field of study
- **Problem Solving:** To apply in-depth knowledge of their chosen field in mechanical engineering using the interdisciplinary approach for problem solving
- **Research and Development:** To adapt, create, transfer, and assimilate current and emerging technologies into new products through relevant research
- **Ethics:** To understand the social and ethical responsibilities
- **Lifelong Learning:** To improve their knowledge and skills continuously for pursuing lifelong learning in the broader context of innovation and technological developments

Eligibility Criteria

- MS/ M.Phil/ equivalent (18 Years of education) with a strong background in relevant discipline with minimum CGPA 3.00 out of 4.00 or First Division (where CGPA not available) from HEC/PEC recognized Institute/University or from Foreign Institute/University of good repute
- Valid GAT-A (General -

Engineering Category) conducted by NTS with $\geq 60\%$ score or Valid HAT-I (Engineering Category) administered by the Education Testing Council (ETC-HEC) with $\geq 60\%$ score or GRE International (General) conducted by ETS, USA, with minimum score as Quantitative: 145, Verbal: 145, Analytical: 3.5 or Valid GAT (Subject) conducted by NTS in the relevant field of study with $\geq 60\%$ score or Minimum 60% marks in test equivalent to GRE/ HAT General/ Subject conducted by the Higher Education Institution (HEI). The IST institutional code to receive GRE scores is 1758.

Research Prerequisites

- Research proposal (intended research work during Ph.D.) approved DBGS. DBGS committee comprises members as per IST policy
- A Ph.D. candidate will be required to give a presentation to DBGS related to his/her research proposal before his/her research direction is finalized

Course work

- Minimum 18 credit hours of course work must be undertaken with a CGPA of 3.00 out of 4.00
- The list of 6 Ph.D. courses must have been approved by DBGS at the time of admission of a candidate and DBGS should have

- also assigned him a supervisor as per IST Policy in vogue
- Migration/ Transfer of the courses from other Universities/ Institutes is allowed as per the IST Migration/ Transfer policy

Comprehensive Examination

- Qualifying exam is conducted after successful completion of the course work
- The comprehensive examination will comprise of written and oral components

- A Minimum of 60 % marks are required to pass the comprehensive exam with a minimum of 40% in each exam
- Students who fail in comprehensive exam will be allowed to reappear in the exam (once only)

Synopsis

After successfully passing the comprehensive exam, a Ph.D. candidate will write his/ her synopsis and present/ defend his/her synopsis

in front of DBGS. The presentation/ defense of the synopsis will be graded by DBGS, written synopsis is 40% and presentation is 60%. The passing marks of synopsis are 60%

Research Work

24 credit hours of research work spanning over at least two years through continuous registration in Thesis-I, Thesis-II, Thesis-III, and Thesis-IV of 6 credits each

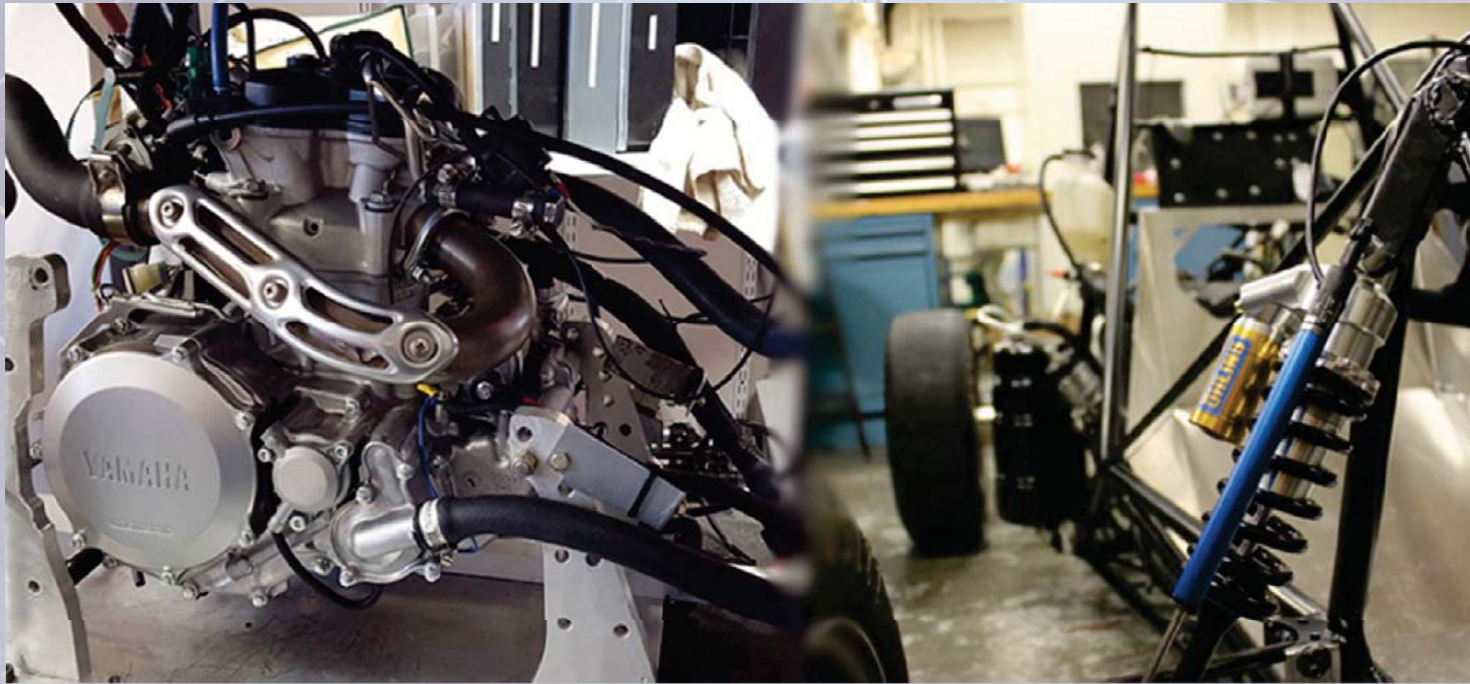

Note: Changes in Ph.D. policy can be made to keep it in compliance with HEC guidelines and rules & regulations. These can be issued without any prior notice and shall apply to all students instantly.

Space Science



With rapid development in the field of space exploration, the subject of space science has gained tremendous importance. Our knowledge about the universe has further expanded by space observations, and diverse space technologies have become an essential part of our daily life. Manufacturing and operation of spacecraft, analysis of data (both in situ and remote sensed observations)



and developing theories with analytic and computational tools are tasks of space science. Space science as an academic discipline of understanding the universe is no more a heavenly, speculative science. On one hand, it touches the most fundamental philosophical questions, for example, how our universe was created, how we come to existence while, on the other hand, it provides the most practical information like the safety of astronauts and spacecraft. Application of space science is not limited to satellite



communication and astronomical observations as perceived in the past. The GPS become an integral of our daily lives. With the help of orbiting remote sensing satellites we are able to monitor the loss from any disasters like flood, earth quakes and landslides in a timely manners helping saving lives and infrastructure. Our department educate students to take part in all those endeavours into space and pioneer the final frontier of the mankind, the universe. This is a place where young curious mind can find answers to their questions regarding space and go beyond the borders to excel the in the field of space science. The global space market is experiencing continuous growth since space technology is one of the key

fields for national competence and economic growth. The space sector is seeking for young professionals with excellent knowledge in space technology and interdisciplinary fields. The Space Science department at IST is a multidisciplinary department with the focus on, Astronomy and Astrophysics, Physics, Remote Sensing and Geographical Information Science, Atmospheric and Environmental Science, Meteorology, Earth Sciences and Astrodynamics. Research laboratories at IST include hi-tech facilities for space and planetary exploration, remote sensing, high-precision positioning and navigation, geospatial information technology, atmospheric measurements, simulations and climate modelling.

Department of Space Science offers the Bachelor of Science Programs in Space Science and Physics. The Master programs are offered in Astronomy and Astrophysics, Remote Sensing and GIS, Environment and Climate Sciences, Global Navigation Satellite Systems and Physics. It also offers PhD in Astronomy and Astrophysics & Remote Sensing and GISc.

Research Labs and Facilities

The following state-of-the-art laboratories are available for research and experimentation.

- Astronomy and Astrophysics Lab
- Modelling and Simulation Lab
- Global Navigation Satellite
- Systems Research Lab
- Geospatial Research and

Educational Lab

- Earth Observation and Photogrammetry Lab
- Remote Sensing and Geographic Information Science Lab
- Environment and Climate Sciences Lab
- Space Education and Research Lab
- Modern Physics and Research Lab
- Computation Lab
- Applied Physics Lab
- Mechanics, Electricity and Magnetism Lab
- Heat, Waves, Sound and Optics Lab
- IST Observatory



MS Remote Sensing and GISc

Introduction

This program is designed to develop early career scientists through quality education in remote sensing and geo-information science and their applications, providing necessary skills to create, process, analyse, and interpret geospatial data, which will be directed towards solving practical problems and addressing outstanding research questions using innovative approaches. The in depth knowledge on key physical process like agriculture, mineral exploration, urban planning, hydrology, climate sciences, facility management, land information system, has been provided so that the student understand the underlying principles and theories in these major fields and utilize their in depth knowledge and remote sensing to solve the problems.

Eligibility Criteria

- BS/ BE/ equivalent (16 Years of education) with a strong background in Remote Sensing & GIS or minimum 16 years of education in the field of Engineering/ Science with minimum CGPA = 2.00 out of 4.00 or = 60% marks (where CGPA not available) from HEC and PEC (where applicable) recognized Institute/University or from Foreign Institute/University of good repute
- GAT-A or GAT-C (General) conducted by NTS in the relevant field of study with = 50% marks or HAT (General) conducted by HEC in the relevant field of study with = 50% marks or GRE International (General) conducted by ETS, USA, with minimum score as Quantitative: 145, Verbal: 145, Analytical: 3.5

The IST institutional code to receive GRE scores is 17583

Semester	Courses	Cr. Hr.
01	Advanced Geographical Information Science	03
	Advanced Remote Sensing and Digital Image Processing	03
	Elective I	03
02	Advanced Research Methods	03
	Advanced Programming and Customizing GIS	03
	Elective-II	03
03	Elective-III	03
	Elective-IV	03
	Thesis-I	03
04	Thesis II	03

Credit Hours: 30 (24 + 6)

Elective Courses

A student may choose an elective course from the list after the approval of program head, research supervisor and HoD. Elective courses will be offered subject to the availability of relevant faculty and a reasonable number of interested students and with the approval of HoD/Dean.

- Advanced Spatial Databases
- Radar Remote Sensing
- Web GIS
- Geostatistics
- Photogrammetry
- Environmental Sciences
- Data Analysis for the Earth Sciences
- Climate Change Adaption and Mitigation

- Strategic Environmental Assessment
- Hydrology and Water Resource
- Machine Learning
- Hydrological modelling using GIS
- Earth System Dynamics
- Hydrometeorology
- Big Geospatial Data Analysis using Google Earth Engine
- Advanced Environmental System Analysis
- Fundamentals of GNSS
- GNSS Augmentation Systems
- Space Weather and GNSS
- GNSS Applications
- Land Information System

Course Description

Core Courses

The broad course description of the four Core / Compulsory Courses is given below however the faculty may modify the outline and details according to requirements.

Advanced Remote Sensing & Digital Image Processing

Intro to Remote Sensing, What is Remote Sensing, Fundamentals of Remote Sensing (LillesandKiefer Ch. 1), Atmospheric interactions: Scattering / Absorption (LillesandKiefer Ch. 1), Resolutions: Spatial, Temporal, Radiometric, Spectral (Gao Ch. 1), Major RS Softwares, Remote Sensing Satellite Orbits, Spectral Signatures: Basis, Examples (Vegetation, Landcover, etc.). Optical Remote Sensing Platforms, Satellites, Along-Track,

Across-Track, Low-medium resolution satellite platforms: Landsat, Sentinel-2, MODIS, AVHRR, etc. High-resolution satellite platforms: WorldView, IKONOS, SPOT, Pleiades, etc. Remote sensing data sources, Hands-on Activity:, Intro to ENVI, Opening different satellite datasets in ENVI. Geometric Errors & Distortions, Errors associated with Earth, Errors associated with Platform, Errors associated with Sensor, Geometric Corrections & Image Rectification, Geometric transformations, GCPs and GCP selection, Image rectification models, Polynomial-based rectification, Polynomial-based image rectification, Mathematical basis, Polynomial order, Error Analysis through RMSE, Hands-on Activity, Intro to ESA SNAP. Polynomial-based image rectification, GCPs and GCP selection, Output image generation, Intensity interpolation: nearest neighbor, bilinear, cubic, Orthorectification (Gao Ch. 5), GCPs and Tie Points, Use of DEM in orthorectification, Hands-on Activity, Basic RS software functions, Band / layer stacking and subsetting, Band combinations and feature identification, ENVI Multiband Analytic Display, Deriving spectral signatures from images, Hands-on Activity, Polynomial-based image rectification in ENVI, Image rectification in ERDAS IMAGINE. Orthorectification (Gao Ch. 5), Use of DEM in orthorectification, Direct georeferencing, Hands-on Activity:

Orthorectification, Atmospheric correction, Radiometric measurement & terminologies, Solid angle & radiance. Atmospheric correction, Solid angle & radiance, Atmospheric influences, Reflectance, Atmospheric correction, Radiometric calibration, Radiance and reflectance, Hands-on Activity, Radiometric calibration, Atmospheric correction. Hands-on Activity, Atmospheric correction with ENVI QUAC, Atmospheric correction with ENVI FLAASH, Atmospheric correction, Remote sensing data levels, Landsat surface reflectance product, Sen2cor, DG AComp, Analysis ready data, Image Enhancement, Contrast Enhancement / Greylevel Transformations. Atmospheric correction, Remote sensing image storage formats: BIL, BIP, BSQ, Image Enhancement, Contrast Enhancement / Greylevel Transformations, Histogram Processing, Image Filtering, Kernel and convolution, Image-filtering in the spatial domain, Low-pass filters, Hands-on Activity, Image enhancement. Image Filtering, High-pass filters. Image Transformations, Band Ratios, Spectral Indices, NDVI, Hands-on Activity, Image filtering. Image Transformations, Spectral Indices, Scatterplots, Soil Line, Kauth-Thomas (Tessellated Cap) transform, PCA, Decorrelation Stretch, Hands-on Activity, Analyzing glaciers with Landsat8, Image transformations: K-T, PCA. Image Transformations: Color spaces, HIS,

Image Fusion and Pan-sharpening, PCA fusion, HSI fusion, other methods, Spatiotemporal fusion, Fusion of optical and SAR data, Image Classification: Mathematical/Geometrical Basis, Classification schemes, Classification methods. Image Classification, Spectral Distance, Unsupervised Classification, k-Means Algorithm, ISODATA Algorithm, Supervised Classification, Basic Idea of Supervised Classification, Supervised Classification Algorithms, Training Step, Classification Step, Maximum Likelihood Algorithm, Hands-on Activity, Image fusion & Pansharpening. Guest Lecture, Multi-temporal datasets and processing on the cloud, Google Earth Engine, Remote Sensing Applications, Supervised Classification, Training Set Selection & Refinement, Classification Accuracy Assessment, Validation Set Generation, Post-classification, Accuracy Assessment, Hands-on Activity, Training set selection, Training set refinement, Maximum Likelihood classification. Classification Accuracy Assessment, Validation Set Generation, Accuracy Assessment, Error Matrix, Users' and Producer's Accuracy, Kappa Coefficient, Remote sensing in the Thermal IR, Thermal emission, Emissivity, Brightness temperature, Blackbody radiation, Remote sensing in the thermal IR, Derivation of LST

Advance Programming and Customizing GIS Python Basics

Python Basics. Introduction to Python. Variables, expressions and statements. Getting user input. Logical operators. Boolean expressions. Conditional Executions and Iterations. If-else statements. While loop. For loop. break, continue and pass statements. The in operator. Arrays. Lists. Tuples. Sets. Dictionaries. Multidimensional arrays Python Modules – Numpy. Strings. String slices. Looping and counting. String comparison. Files. Reading and Writing Files. Searching through files. Functions. Built-in functions. Type conversion functions. Math functions. User Defined functions. Python Modules – Matplotlib. Plotting. Subplots. Images. Error and Exceptions. Syntax errors. Exceptions. Handling exceptions. Introduction to OOPs in Python. Classes. Objects. Methods. Inheritance. Encapsulation. Polymorphism. PYTHON GIS. Geoprocessing in ArcGIS. What is geoprocessing? ArcObjects. Using models and ModelBuilder. Using scripting. Using tools. Exploring Spatial Data. Checking for the existence of data. Describing data. Listing data. Working with lists. Working with tuples. Working with dictionaries. Manipulating Spatial Data. Using SQL in Python. Working with table and field names. Parsing table and field names. Working with text files. Working with Geometries. Reading geometries. Working with

multipart features. Working with polygons with holes. Writing geometries. Using geometry objects to work with geoprocessing tools. Working with Raster. Listing raster. Describing raster properties. Working with raster objects. Working with the ArcPy Spatial Analyst module. Using map algebra operators. Map Scripting. Working with the ArcPy mapping module. Opening map documents. Accessing map document properties and methods. Working with data frames. Working with layers. Working with page layout elements. Exporting maps. Printing maps. Working with PDFs. Creating and Using Script Tools. Steps to creating a tool. Editing tool code. Setting tool parameters. Customizing tool behaviour. Working with messages. Handling messages for stand-alone scripts and tools. Running a script in process. Python Scripting for Web-GIS (optional)

Advanced Geographical Information Science

What is GIS?. Evolution of GIS, geographical data, Coordinate systems and Map projections, Raster/Vector conversions, Error estimations and rectification due to projection systems and cartographic procedures, advanced editing of spatial data, Symbolization and Map layouts development. Describing and analysing fields, Area Objects and Spatial autocorrelation, 3D Visualization of Spatial Data, Geocoding and survey data integration in GIS, Point Pattern

analysis. Lines and Networks, Performing Network analysis, Geo-statistical analysis, Map Overlay analysis, Multivariate data analysis, Multidimensional Space, GIS Modelling and Simulation, watershed analysis, spatial interpolation techniques and so on.

Advanced Research Methods Introduction

Introduction. Defining research through different perspectives. Scope of Research. Research and theory. The scientific approach. Stages of research process. Ethics of Research. Principals of Right to Know and Right to Protect. Ethical dilemmas and conflicts. Information Acquisition. Sources of research topics and questions. Literature review and the exploratory study. Introduction to Library Resources. Primary and secondary sources. Specification of objectives. Hypotheses Uni-variate, Bi-variate, Multivariate and Characteristics of a Testable Hypothesis-e Null Hypothesis and Alternate Hypothesis. Concepts and variables. Assessment Of Short Comings and Reliabilities of Measurement. Levels of measurement: nominal, ordinal, interval and ratio. Reliability and validity. Construction of composite scores: typology, index and scaling. Problems of making causal inference. Study Designs and Measurement. Basic elements of study design. Major types of design and their

relative functions. Qualitative Research Methods. Field research. Focus groups. Participatory research appraisal. Elite interviews. Quantitative Research Methods i. Experimental research ii. Aggregate data (Analysing existing statistics) iii. Content analysis (Analysing recorded human communications). Social Survey Methods i. The Interview Method ii. The Questionnaire Method iii. Formulating Questions for a Survey iv. Survey Implementation Editing, Coding and Data Entry vi. Analysis of Survey Data vii. Writing a Survey Report. Evaluation Research Methods i. Social survey ii. Case study: its exploratory nature. Reliability and validity of measurement. Level of Measurement i. Cross-sectional, Longitudinal, and Sequential Designs. Sampling. Population and the source list. Sampling errors and sample size. Probability sampling. Non-probability sampling. Data Collection Methods. Interview and questionnaire 1. Structured 2. Semi-structured 3. Unstructured. Observation. Documents and content analysis. Unobtrusive measures. Data collection issues. Data Analysis and Interpretation. Editing, coding, and tabulation. Statistical analysis: Description and inference. The meanings and implications of results: why so and so what? Anticipated Out Puts. Formulating the research proposal. Writing the research report. Research Publications. Excelling the art of a scientific

flowchart for synopsis, research paper and thesis using MS visio. Using origin Pro for high resolution graphs and charts. Mastering Endnote for citation and bibliography.

Employment Prospects

The geo-information sciences have applications in a wide range of disciplines including environment, energy sector, agriculture, natural resources management, disaster management, communications etc. The following is a non- exhaustive list of some national-level private and public sector organizations, which could utilize the graduates in remote sensing & geo-information sciences:

- Institutions/organizations tackling engineering problems/projects
- Strategic organizations of Pakistan and teaching institutions

PhD Remote Sensing and GISc

The PhD program in Remote Sensing and Geographical Information Science (GISc) has been designed to develop scientists through quality education and research in the fields of remote sensing and geographical information science. The core scientific goals of this program are to understand the Earth's physical environment from a geographical and spatial perspective, to advance our knowledge about geophysical processes, and to contribute towards advancing the social and technological applications of space-based and location-based technologies and data. The program will provide its graduates the skills to analyze and interpret remote sensing and geographical data, and the guidance and motivation to address outstanding research questions in the study domain using innovative approaches, both independently and as part of interdisciplinary teams.

Eligibility Criteria

- MS/ M.Phil/ equivalent (18 Years of education) with a strong background in relevant discipline preferably Space Science, GIS, Geoinformatics, Geology / Geophysics, Environmental Science, Water Resources Engineering, Computer Science, Geology, Electrical Engineering, and others, with minimum CGPA

3.00 out of 4.00 or First Division (where CGPA not available) from HEC/ PEC recognized Institute/University or from Foreign Institute/University of good repute

- Valid GAT (General) conducted by NTS in the relevant field of study with $\geq 60\%$ score or Valid HAT administered by the Education Testing Council (ETC-HEC) in the relevant field of study with $\geq 60\%$ score or GRE International (General) conducted by ETS, USA, with minimum score as Quantitative: 145, Verbal: 145, Analytical: 3.5 or Valid GAT (Subject) conducted by NTS in the relevant field of study with $\geq 60\%$ score or Minimum 60% marks in test equivalent to GRE/ HAT General/ Subject conducted by the Higher Education Institution (HEI). The IST institutional code to receive GRE scores is 1758.

Research Areas

The Remote Sensing and GISc group at IST have highly qualified faculty with significant international collaborations and access to well-equipped facilities, abroad as well as in Pakistan. Currently research is carried out in several domains of Remote Sensing and GISc:

- Multi-spectral and Hyper-spectral Remote Sensing
- Microwave Remote Sensing
- Photogrammetry

- Geographic Information Science
- Climate Modelling
- Water Resources Modelling

Course work

- To receive the PhD in Remote Sensing and GISc, students must complete a total of 6 courses (3 credit hours each) along with 24 credit hours of research thesis and one publication
- In addition to the minimum 18 credit hours course work, prerequisite courses of the core course work will be notified as "Deficiency Courses" and shall not be counted towards the degree and calculation of CGPA
- The student Graduate Education Committee (GEC) may even specify additional courses to be taken by a student, if considered essential. These will be notified as "Additional Courses" and shall not be counted towards calculation of CGPA
- The IST policy for award of PhD degree will be applicable

Following courses will be offered (subject to the availability of relevant faculty) for the course work:

- Applied GIS based Geographical Analysis
- Remote Sensing Image Analysis and Applications
- Spatial Statistics
- Advanced GIS Theory
- Spatial Data Structures and Algorithms
- Data Analysis for Earth Sciences
- Satellite Oceanography
- Radar Remote Sensing

- Hydrological modelling and management systems
- Geo-informatics for Disaster Management
- Advanced GPS & applications
- Spatial Databases
- GIS Programming and Automation
- Web and Mobile GIS
- Special Topics in GIS
- Photogrammetry
- Machine Learning
- Big Geospatial Data Analysis using Google Earth Engine
- Land Information Systems
- Global Warming and Climate Change
- Deep Learning

Course Description Applied GIS based Geographical Analysis

The general expectations of this course are the following: to support the efficient use of methods and tools of GIS technology to gather, and organize geographical information, to present methods to combine geographical information from various sources within GIS to research a geographical issue, to show how we can analyze and interpret geographical data using a variety of GIS-based methods.

The course includes the following: Advanced GIS, spatial models and transformations, massive data input, GIS-based spatial analysis, terrain modeling and analysis, identification of spatial patterns, Map Algebra, GIS-based spatial decision support systems, GIS-based multi criteria analyses - analytical hierarchy

process, spatial network analyses, GIS applications, practical exercises.

Remote Sensing Image Analysis and Applications

This course focusing on remotely sensed data for geospatial applications. Students will develop a strong understanding of the tools and techniques used to display, process, and analyze remotely sensed data. Upon completion of the course students will be able to:

- Process remotely sensed data to make it useful in geographical information systems;
- Perform image enhancement on remotely sensed imagery;
- Extract information from remotely sensed data using a variety of manual and automated techniques;
- Critically assess the strengths and weaknesses of remote sensing instruments and platforms for a variety of application scenarios;
- Develop multi-step remote sensing workflows to solve problems in a variety of application areas;
- Apply acquired knowledge and critical thinking skills to solve a real-world problem with appropriate remote sensing data and processing methods;
- Clearly and concisely communicate findings from the analysis of remotely sensed data through the written word and graphical products.

Spatial Statistics

This course will introduce the basics of statistics and their applications in geographical research. Students will be exposed to both descriptive and inferential statistics, with an emphasis on geographical applications. This course focuses on statistical analysis and spatial statistics, since these methods are crucial to anyone having to deal with spatially-oriented problems.

The course includes role of statistics in geography, statistical techniques characteristics and preparation, spatial data and descriptive statistics, basic probability, discrete probability, continuous probability distribution, elements of sampling, estimation of sampling, elements of inferential statistics, categorical difference tests, inferential spatial statistics, point and area pattern analysis, correlation, linear regression, multivariate regression.

The outcomes of this course will be:

- Basic knowledge of the characteristics and factual information associated with a statistical technique or concept;
- Understanding and interpretation of the purposes and objectives of a technique;
- Explanation of why a technique is important, and the limitations of the

- technique;
- Creative identification of geographical problems that can be solved by a technique;
- Ability to know how to collect data, choose the appropriate statistical techniques and analyze the data according to research questions.

Advanced GIS Theory

Understanding the core of a Geographical Information Systems (GISs) is of utmost importance. The course will show that there are strong mathematical principles behind the construction of GISc and these principles can be presented as a formal theory. It will be shown that how a GIS is constructed from small set of primitive notions and axioms defining them. Category theory and in particular functors are the guiding principles to identify components and to compose them. Topics included are Introduction to information systems, Formal languages and theories, Algebras and categories, Geographical space and time, Functors, Duality in projective space: Infinite geometric lines in 2D, Generalization to n-Dimensions: Flats, Point set topology, Algebraic topology-simplex and complex, Graphs, Cells, Movement in space: changing vectors

Spatial Data Structures and Algorithms

Spatial data structures are used for storing geometric information, enabling efficient retrieval,

manipulation and visualization using spatial algorithms. Spatial data structures and algorithms solve geometric problems often with proven worst case complexities. Computational geometry, an important branch of mathematics, offers techniques that form the foundations for spatial data structures and algorithms for solving many geometric problems in GIS. The course will explore fundamental spatial data structures and algorithms, and their trade-offs (in performance) for solving spatial problems. Significant programming tasks are to be expected, as students will implement most the data structures and algorithms in their programming language of choice.

Major topics include computational geometry, search and intersection, Polygon Triangulations, Voronoi Diagrams, Delaunay Triangulations, Convex hulls, Hierarchical data structures, Multi-dimensional data structures and algorithms, Spatio-temporal data structures and algorithms, Data structures for moving objects, Parallel and distributed data structures, Spatial data visualization, Shortest path algorithms

Data Analysis for Earth Sciences

This extensive course focuses on data analysis methods and techniques for datasets related to

earth sciences, remote sensing, and geographical information science. It gives exposure to students on a variety of traditional and modern quantitative mathematical / statistical methods for analysing data. The course will require extensive use of MATLAB as a programming and data analysis tool. Regular assignments will be given, and will form an integral part of the course learning. A course project will let students apply the data analysis methods learnt in class on real datasets of their own choice. The output of the class project will be in the form of a presentation and report. Major Topics include MATLAB, Data types, Data analysis techniques, Sampling, Sampling interval and sampling duration, Nyquist Sampling theorem, Random variable probability, PMF, CDF and PDF. Descriptive statistics, Degree of freedom, Theoretical probability distributions, central limit theorem, statistical hypothesis testing, regression, Fourier transforms applications, time series analysis, analysing and plotting directional data, principle component analysis, objective analysis, filtering, image processing, handling geolocated and scientific data formats.

Satellite Oceanography

This is an extensive course on the theory and applications of remote sensing observations of the ocean. Theory discussion will include a review of electromagnetic waves, polarization, absorption, and scattering processes, which will lead to discussions of different

applications and methods of ocean remote sensing. Discussion on methods and applications of ocean remote sensing will include infrared remote sensing, ocean color, sea surface temperature, ocean salinity, SAR, scatterometry, satellite altimetry, and microwave radiometry. Regular assignments will be given.

A course project will let students choose one specific application/instrument and apply the concepts learned in class to study its operation and perform some data analysis. The output of the class project will be in the form of a presentation/report. More details about the project will be provided during the course.

Major Topics included in the courses are Electromagnetic Waves, Physical Oceanography, Ocean colour observations, SST observations, Radar altimetry, SAR imaging of the ocean surface, Ocean salinity through SMOS, Future satellite oceanography missions.

Radar Remote Sensing

This is an extensive course on remote sensing using active radar. It presents an overview of radar basics, radar signals, interaction of radar with targets, and different remote sensing applications. It is expected that students will develop a quantitative understanding of radar system design and requirements for remote sensing, how different kind of targets interact with radar signals, and how the analysis of these returned signals can help us in gaining information about different properties of the target, e.g. composition, structure, shape etc.

This course will not prepare you to build a radar hardware system, rather how the radar system can be used for remote sensing and extracting useful information from targets using remote sensing.

A course project will let students work on processing and analyzing data acquired from a radar remote sensing instrument of their choice, and present the results.

Major topics include Radar fundamentals, Mathematics for Radar II, Radar Equation with noise and losses, Antennas, Imaging Radar, Mathematics for Radar IV, V. Pulse compression, Geometric Distortions in imaging radar, radar scattering processes, Radar RS applications, Ocean surface imaging with Radar/SAR.

Hydrological Modeling and Management Systems

This course develops a quantitative approach to understanding, estimation, and prediction of different components of the hydrologic cycle. Modeling of the following processes will be discussed in this course:

Interception, snow melt, evapotranspiration, infiltration, groundwater flow, overland runoff, stream flow, sediment erosion and deposition, and transport of contaminants in streams, the course discusses in detail multiple model representations of hydrologic processes, and limitations and uncertainty associated with each. After successful completion of this course, students will possess an in-

Geo-informatics for Disaster Management

The main objective of the course is to present the use of Geo-informatics in risk management. The main objectives of the course are:

- to evaluate the spatial data requirements in disaster risk management,
- to apply GIS and RS to hazard, vulnerability and risk assessment,
- to assess spatial data availability and understand their importance in disaster risk management,
- to apply advanced RS-based techniques to monitor disasters and assess damages, and
- to design and construct GIS-based projects for the analysis and management of various natural disasters in a geospatial framework

Content of the course

RS: Earth observation data, operational capability, specific techniques in hazard assessment, high resolution data in emergency planning.

GIS: GIS overview – geographical modeling within GIS technology – an overview of GIS applications in natural disaster managements – mapping natural disasters, practical exercises.

Advanced GPS & Applications

This course intends to cultivate a working knowledge of current and future capabilities of GPS and the emerging Global Navigation Satellite System. The course includes the GPS Signal, understanding of the basic GPS signal structure, Biases and

Solutions, technological forerunners of GPS, recognize terrestrial radio positioning, optical systems and extra-terrestrial radio positioning, receivers and methods, Geodetic datum, Static, DGPS and RTK, techniques of GPS observing and data processing, GPS Modernization and GNSS.

At the successful completion of this course, students should be able to:

- Demonstrate a clear understanding of the GPS signal, codes and biases
- Discuss the practical applications of GPS and the implications of its modernization
- Be aware of some of the opportunities afforded by the coming GNSS systems
- Explain the difficulties inherent in determining heights with satellite positioning and how they can be overcome
- Describe the differences between relative and autonomous GPS positioning, code phase carrier phase, DGPS and RTK

Spatial Databases

The course aims to familiarize students with the spatial (geographical) databases. The course includes the following modules: Databases and database management systems, design and implementation of database systems, SQL language, spatial databases, geometry types, spatial operators, spatial indexes, commercial and open source databases of geographical data

management systems. During the semester, the students prepare a series of laboratory exercises in Software Management Systems Geographical Data Base (PostgreSQL/PostGIS).

Upon completion of the course students should be able to:

- Retrieve data from an existing database using SQL Select queries
- Design a database schema from a set of requirements
- Implement that design through the creation of related tables
- Create spatially enabled tables in Postgres/PostGIS
- Work with PostGIS data using open-source desktop GIS software
- Answer questions using PostGIS spatial functions
- Model real-world entities through subtypes, domains, topology rules, and relationship classes
- Discuss the suitability of an open-source or proprietary approach to various project scenarios

GIS Programming and Automation

This course teaches how to automate GIS tasks using the Python scripting language. Automation can make your work easier, faster, and more accurate, and knowledge of a scripting language is a highly-desired skill in GIS analysts. The course includes introduction to GIS modeling and Python, GIS customization, ArcGIS Model Builder, Python script tools, functions and

modules, reading and parsing text, decision structures, Strings, Troubleshooting, Batch processing, GIS Data Access and Manipulation with Python, Practical Python for the GIS Analyst.

By the end of this course, you should be able to:

- Design and implement solutions in Python (and Model Builder) to automate geoprocessing tasks.
- Demonstrate an understanding of programming concepts, methods, and approaches such as debugging, error checking, and documentation.
- Demonstrate an awareness of advanced concepts such as external libraries.
- Be aware of and able to integrate content, examples, and concepts from external resources such as esri.com (link is external) and stackoverflow.com (link is external).

Web and Mobile GIS

The aim of the course is to teach students the fundamental theories and technologies for disseminating and processing geographical information by means of Internet and World Wide Web. For this, two specific distributed GIS architectures are studied: the Web-based and the mobile GIS architectures. It is demonstrated through case studies, laboratory exercises, and group projects that these architectures and related technologies allow 1) the creation of dynamic web maps and Internet-based geographical

analysis, and 2) the provision of GIS functionality in the field through mobile GIS solutions and in a commercial setting in the form of Location-Based Services (LBSes). At the end of the course, students should know how to design and implement web maps, Internet-based geographical analysis, and mobile GIS and LBS solutions.

Course main content

- Basics of computer networking, Internet, WWW
- Client/server computing and the distributed component framework
- Open source and commercial (ESRI) Internet mapping software
- Standards for distributed GIS services
- Design and implementation of dynamic maps and geographical analysis via the WWW
- GPS and Mobile GIS concepts
- Professional GPS and mobile devices
- ESRI Mobile GIS software
- Mobile solutions for capturing, storing, updating, analyzing, and displaying geographical information

Special Topics in GIS

Geographical information system (GIS) is being used today by everyone from scientists to everyday citizens for solving geographical problems. The range of these problems varies from very simple to extremely complex. This course will address special topics in GIS technology. The course will concentrate on a specific GIS

project relevant to the student's major issues including project planning, management, and evaluation. Students will explore GIS theory and practice related to the visualization, measurement, transformation, and optimization of spatial data. In this course, a variety of analytical techniques including applied statistics and spatial methods will be used. Students will learn how to execute the entire lifecycle of a data analytics project including problem formulation, data preparation, exploratory analysis, modelling and visualization. The students will gain an extensive knowledge about various GIS analysis techniques, methods, outputs and uncertainties as they relate to specific problems experienced in various situations. This course will give the students an opportunity to piece together previous knowledge and gain a greater sense of understanding about GIS. Students will also learn how to automate their geospatial analysis workflow using Model Builder and Python scripting.

Photogrammetry

This is a graduate level course on Photogrammetry, which deals with the extraction of geometric information from multi view images. This course provides introduction to imaging geometry and then covers topics related to orientation of multiple images together with extraction of 3D information. Special focus will be given to generating Digital Surface Models from stereo and multi view images. These

images may be acquired from airborne or space borne imaging sensors. The main topics are: camera intrinsic and extrinsic parameters, collinearity equations, camera calibration, relative orientation, Fundamental and Essential matrices, stereo rectification, dense stereo matching (cross correlation and semi global matching), triangulation and rational polynomial coefficients for satellite image orientation. An introduction to computer vision techniques for automatic extraction and detection of corresponding points like SIFT and SURF will also be presented. Towards the end of the course, a brief overview on laser scanning and 3D cameras will be presented. There will be exercises in MATLAB pertaining to topics of image orientation and image matching. The practical applications of this course cover following areas: digital surface and digital terrain models as well as and 3D reconstruction from multi view images

Machine Learning

Machine Learning is basically the study of techniques and algorithms designed to learn from data. The data could come from various sources or could be in different formats. In the current course our focus will be on data in the remote sensing and computer vision fields i.e. color images, hyper and multi spectral images, time series imagery, 3D point clouds etc. This course will start with the unsupervised learning (clustering algorithms like k-means) and introduce the concepts of

dimensionality and features extraction which will then lead to the topic of dimensionality reduction (Principal Component Analysis) and data decorrelation. After this introductory part, this course will cover the supervised learning techniques like logistic regression, neural networks and support vector machines. In order to understand these techniques mathematical basis of cost function and optimization will be introduced along with the practical examples in MATLAB. The backpropagation algorithm in neural networks will be covered in detail. Due to the recent breakthroughs in Deep Learning major portion of the course will cover the topics in neural networks and deep learning like image classification, image segmentation, object detection and recurrent networks. Deep learning networks like AlexNet, ResNet, U-Net and LSTM will be used in practical exercises for various machine learning tasks. Towards the end of the course support vector machines, decision trees and random forest algorithms will be presented along with some practical applications

Big Geospatial Data Analysis using Google Earth Engine (GEE)

In this course students will be introduced to and practice working in the Earth Engine Code Editor platform, explore some remote sensing programming concepts, and learn about Earth Engine data structures and methods, functions,

algorithms, and develop own mapping products during a mini-project. Google Earth Engine (GEE) is a cloud based geospatial remote sensing processing platform, complete with an extensive public data catalog. It is available via a web-based JavaScript Application Program Interface (API) called the Code Editor. This platform is where users can write and execute scripts to share and repeat geospatial analysis and processing workflows, such as Satellite image interpretation, Satellite Image Pre-Processing (Subset, Terrain Correction etc.), mathematical operations and indices, land cover mapping and change assessment. Major topics include:

- Introduction to the GEE, including the Code Editor
- Explore basic JavaScript and Earth Engine programming concepts
- Become familiar with a sample of basic geospatial applications in Earth Engine
- Introduce available resources for continued learning of Earth Engine concepts
- Computations and visualization of satellite images

The students will be able to apply basic knowledge of Remote Sensing domain using Google Earth Open Platform for the solution of real world problems related to Time Series Satellite Imagery, Topographic and Climatic datasets processing. They will also be able to critically analyse and evaluate different methodologies and scenarios for the

development of geospatial systems

Land Information Systems

Land information is a prime requisite for making decisions related to land investment, land development, and land management. The developments in geo-information & communication technology (Geo-ICT) adds new challenges to address a variety of land resource development, management and planning issues particularly in the development and improvement of a reliable land management system. Land information system (LIS) is an up-to-date information system in which the parcels attribute information (ownership, rights, area) the parcel's graphical information (boundary, shape, location) are recorded and maintained in a proper manner. It consists of processes for acquiring, processing, storing, and distributing information about land to ensure secure land tenure and support land valuation, land use planning and land development. The main objective of this course is to discover, apply, and assess these concepts and technologies to deploy them in the creation and maintenance of scalable real-world LIS.

In this course, the students will study all the phases, starting from enterprise architectures, gathering user requirements, applying tools for modelling use cases for software and database development, software development methodologies, querying and managing spatial databases,

deployment, implementation and ending at maintenance. A prototype LIS will be developed, focusing on data modelling, data editing, data sharing, and dissemination. For the practical and assignment the country's land record management system will be discussed using state-of-the-art software and land record data-sets. Both institutional and technical issues of the existing land record management system in the country will be considered.

The outcomes of this course will be:

- explaining the role of information systems for land administration
- applying methods for the design of LIS (user requirements, use cases)
- applying modelling tools for the development of LIS
- designing a simple prototype LIS
- evaluating both the institutional and technical challenges of LIS

Global Warming and Climate Change

In this course, the global environment issues involving climate change due to natural climate variations or human activities are presented for students with a background in the sciences. A quantitative introduction to the new science of climate modeling will be provided in order to understand and predict changes in the climate system. The course will cover basic

principles of regional and global climate changes, and climate data analysis methods both for gridded observations and model simulated for climate variability, extreme climate events, climate change impact assessment under different associated with shared socio-economic and representative concentration pathways simulated under the frame work of Coupled Model Inter-comparison Projects

Employment Prospects

The geo-information sciences have applications in a wide range of disciplines including environment, energy sector, agriculture, natural resources management, disaster management, communications etc. The following is a non- exhaustive list of some national-level private and public sector organizations, which could utilize the graduates in remote sensing & geoinformation sciences:

- Landmark Resources Pvt. Ltd. Islamabad
- TPL Maps Pvt. Ltd
- United Nations Development Program
- Capital Development Authority, Islamabad
- Pakistan Telecommunication Company Limited (PTCL), Islamabad
- Pakistan Council of Research in Water Resources (PCRWR), Islamabad

- Global Change Impact Studies Centre, Islamabad
- National Agricultural Research Council, Islamabad
- Pakistan Space and Upper Atmosphere Research Commission (SUPARCO)
- National Engineering Services Pakistan (NESPAK)
- Survey of Pakistan
- Sui Northern Gas Pipeline Pvt. Ltd.
- National Highway Authority
- National Database & Registration Authority (NADRA)
- Telecommunication Companies
- Pakistan Meteorological Department

Note: Changes in PhD policy can be made to keep it in compliance with HEC guidelines and rules & regulations. These can be issued without any prior notice and shall be applicable to all students instantly.

MS Physics

Introduction

Discipline of Physics lies at the core of scientific and technical domains. The program is designed to develop graduates through quality education and research in physics. Through this program students shall acquire a solid theoretical foundation as well as strong analytic, quantitative, experimental and problem-solving skills that shall enable them to perform research and tackle challenges at the cutting edge of scientific and technological horizon.

Eligibility Criteria

- BS/ BE/ M.Sc./ equivalent (16 Years of education) with a strong background in Physics/ Applied Mathematics/ Space Science or Engineering in any discipline with minimum CGPA = 2.00 out of 4.00 or = 60% marks (where CGPA not available) from HEC and PEC (where applicable) recognized Institute/ University or from Foreign Institute/ University of good repute
- Valid GAT (General) conducted by NTS in the relevant field of study with = 50% marks or HAT (General) conducted by HEC in the relevant field of study with = 50% marks or GRE International (General) conducted by ETS, USA, with minimum score as Quantitative: 145, Verbal: 145, Analytical: 3.5
- Students may need to clear an entry test or interview or both as decided by department at time of admission

The IST institutional code to receive GRE scores is 1758

Elective Courses

A student may choose an elective course from the list after the approval of program head, research supervisor and HoD. Elective courses will be offered subject to the availability of

relevant faculty and a reasonable number of interested students and with the approval of HoD/Dean.

Semester	Courses	Cr. Hr.
01	Mathematical Methods of Physics	03
	Advanced Classical Mechanics	03
	Elective-I	03
02	Advanced Quantum Mechanics	03
	Advanced Electrodynamics	03
	Elective-II	03
03	Elective-III	03
	Elective-IV	03
	Thesis-I	03
04	Thesis II	03

Module – I (Astronomy & Astrophysics)

- Stellar Astronomy & Astrophysics
- Theoretical Astrophysics
- Galaxies
- Astrostatistics
- General Relativity
- Cosmology
- Gravitational Waves Data Analysis
- Binary Stars
- Astronomical Methods: Observations and Data Analysis
- High Energy Astrophysics

Module-II (Plasma Physics)

- Statistical Physics
- Plasma Physics I
- Plasma Physics II
- Experimental Techniques in Plasma Physics
- Industrial Plasma Physics
- Spacecraft Environment Interaction

Module-III (Material Physics)

- Material Science
- Advanced Characterization Techniques
- Crystal Structure and Analysis
- Thermoelectric Materials and Devices
- Applied Vacuum Science and Technology
- Processing of Materials
- Electronic and Magnetic Materials
- Methods and Techniques of Experimental Physics

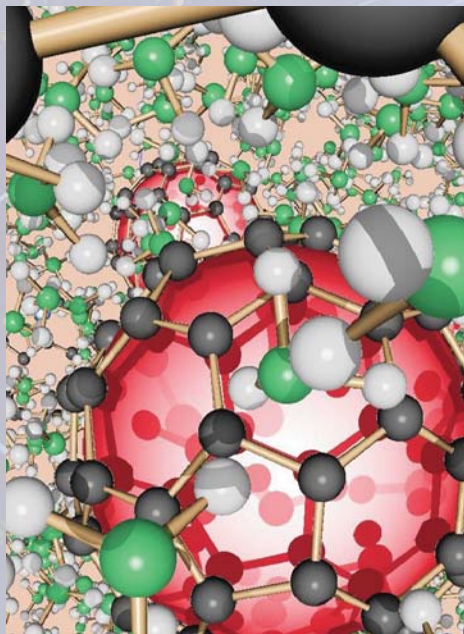
**Course Description****Core Courses**

The broad course description of the four Core / Compulsory Courses is given below however the faculty may modify the outline and details according to requirements.

Mathematical Methods of Physics

Fourier series: introduction and general properties, convergence of trigonometric series, Gibb's phenomenon, Parseval's theorem, applications to various phenomena. Integral transform, development of the Fourier integral, Fourier transform, inversion theorems, Fourier transform of derivatives, convolution theorem, momentum representation, transfer functions. Complex arguments in Fourier transforms, Laplace transform, Laplace transform of derivatives, convolution products and Faltung's theorem, inverse Laplace transform. Partial differential equations. Separation of variables in three dimensions, method of characteristics. Boundary value problems. Integral transforms, generating functions, Neumann series, separable (degenerate) kernels, Hilbert-Schmidt theory, and integral equations. Calculus of variations: dependent and independent variables, Euler-Lagrange equation and applications, several independent and dependent variables, Lagrange multipliers, variational principle with constraints, Rayleigh-Ritz variational technique, application to discrete mesh. Nonlinear methods and chaos, the logistic map, sensitivity to initial conditions and parameters, nonlinear differential equations. Probability: definitions and simple properties, random variables, binomial distribution, Poisson distribution, Gauss's normal distributions, statistics

Advanced Classical Mechanics

Survey of the elementary principles, Variational principles and Lagrange's equations, Oscillations. The classical mechanics of the special theory of relativity, Hamiltonian equations of motion, canonical transformations, Hamilton-Jacobi theory and Action angle variable, Classical Chaos, Canonical perturbation theory, Introduction to the Lagrangian and Hamiltonian formulations for continuous systems and fields, Classical mechanics of liquids and deformable solids; stress, deformation and strain flow.

Advanced Quantum Mechanics

Waves and particles. The mathematical tools of quantum mechanics. The postulates of quantum mechanics, spin $\frac{1}{2}$ particle, the one-dimensional harmonic oscillator, general properties of angular momentum in quantum mechanics. Particle in a central potential: the hydrogen atom

Electrodynamics

Coulomb's Law , Electric Field , Gauss's Law , Differential Form of Gauss's Law , Another Equation of Electrostatics and the Scalar Potential ,Surface Distributions of Charges and Dipoles and Discontinuities in the Electric Field and Potential , Poisson and Laplace Equations, Green's Theorem, Uniqueness of the Solution with

Dirichlet or Neumann Boundary Conditions Formal Solution of Electrostatic Boundary-Value Problem with Green Function, Electrostatic Potential Energy and Energy Density; Capacitance, Variational Approach to the Solution of the Laplace and Poisson Equations, Relaxation Method for Two-Dimensional Electrostatic Problems. Boundary- Value Problems in Electrostatics I: Method of Images, Point Charge in the Presence of a Grounded Conducting Sphere, Point Charge in the Presence of a Charged, Insulated, Conducting Sphere, Point Charge Near Conducting Sphere at Fixed Potential, Conducting Sphere in a Uniform Electric Field by Method of Images, Green Function for the Sphere; General Solution for the Potential, Conducting Sphere with Hemispheres at Different Potentials, Orthogonal Functions and Expansions, Separation of Variables; Laplace Equation in Rectangular Coordinates, A Two-Dimensional Potential Problem; Summation of Fourier Series, Fields and Charge Densities in Two-Dimensional Corners and Along Edges, Introduction to Finite Element Analysis for Electrostatics. Boundary-Value Problems in Electrostatics II: Laplace Equation in Spherical Coordinates, Legendre Equation and Legendre Polynomials, Boundary-Value Problems with Azimuthal Symmetry, Behaviour of Fields in a Conical Hole or Near a Sharp Point, Associated Legendre Functions and the Spherical Harmonics, Addition Theorem for Spherical Harmonics,

Laplace Equation in Cylindrical Coordinates; Bessel Functions, Boundary-Value Problems in Cylindrical Coordinates, Expansion of Green Functions in Spherical Coordinates, Solution of Potential Problems with the Spherical Green Function. Expansion, Expansion of Green Functions in Cylindrical Coordinates, Eigenfunction Expansions for Green Functions, Mixed Boundary Conditions, Conducting Plane with a Circular Hole, Multi-poles, Electrostatics of Macroscopic Media, Dielectrics: Multi-pole Expansion, Multi-pole Expansion of the Energy of a Charge Distribution in an External Field,

Elementary Treatment of Electrostatics with Ponderable Media, Boundary-Value Problems with Dielectrics, Molecular Polarizability and Electric Susceptibility, Models for Electric Polarizability, Electrostatic Energy in Dielectric Media. Magnetostatics, Faraday's Law, Quasi-Static Fields: Introduction and Definitions, Biot and Savart Law, Differential Equations of Magnetostatics and Ampere's Law Vector Potential, Vector Potential and Magnetic Induction for a Circular Current Loop, Magnetic Fields of Localized Current Distribution, Magnetic Moment, Force and Torque on and Energy of a Localized Current



Distribution in an External Magnetic Induction, Macroscopic Equations, Boundary Conditions on \mathbf{B} and \mathbf{H} , Methods of Solving Boundary-Value Problems in Magnetostatics, Uniformly Magnetized Sphere, Magnetized Sphere in an External Field; Permanent Magnets, Magnetic Shielding, Spherical Shell of Permeable Material in a Uniform Field, Effect of a Circular Hole in a Perfectly Conducting Plane with an Asymptotically. Uniform Tangential Magnetic Field on One Side, Numerical Methods for Two-Dimensional Magnetic Fields, Faraday's Law of Induction, Energy in the Magnetic Field, Energy and Self- and Mutual Inductances, Quasi-Static Magnetic Fields in Conductors; Eddy Currents; Magnetic Diffusion, Maxwell Equations, Macroscopic Electromagnetism, Conservation

Laws: Maxwell's Displacement Current; Maxwell Equations, Vector and Scalar Potentials, Gauge Transformations, Lorenz Gauge, Coulomb Gauge, Green Functions for the Wave Equation, Retarded Solutions for the Fields: Jefimenko's Generalizations of the Coulomb and Biot-Savart Laws; Heaviside-Feynman Expressions for Fields of Point Charge, Derivation of the Equations of Macroscopic Electromagnetism, Poynting's Theorem and Conservation of Energy and Momentum for a System of Charged Particles and Electromagnetic Fields, Poynting's Theorem in Linear Dissipative Media with Losses, Poynting's Theorem for Harmonic Fields; Field Definitions of Impedance and Admittance, Transformation Properties of Electromagnetic Fields and Sources Under Rotations, Spatial

Reflections, and Time Reversal, On the Question of Magnetic Monopoles, Discussion of the Dirac Quantization Condition, Polarization Potentials (Hertz Vectors).

Employment Prospects

Students completing this program shall acquire broad knowledge and skills to work in various organizations looking for physicists. Scope for our graduates will be in:

- Strategic organizations of Pakistan and public/private universities as well as organizations.
- Pursue higher studies at national/international universities and research organizations.
- Pursue higher studies at national/international level



Applied Mathematics & Statistics

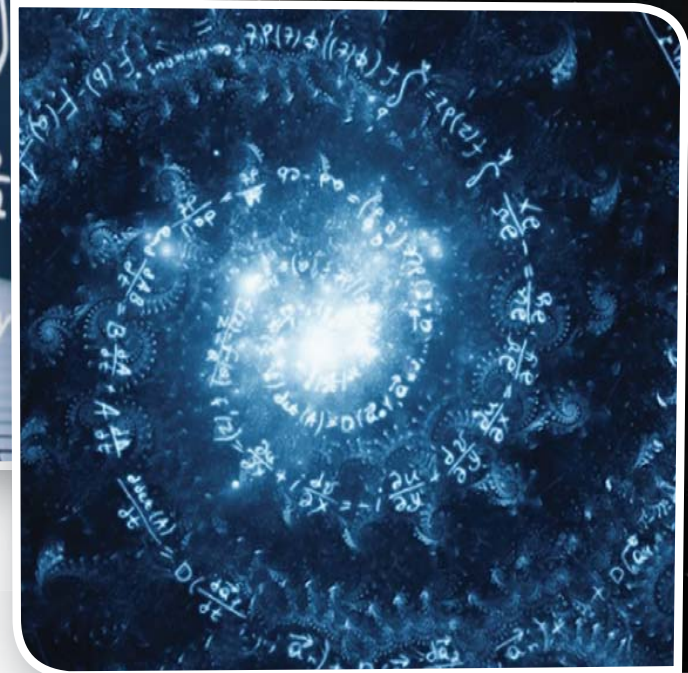
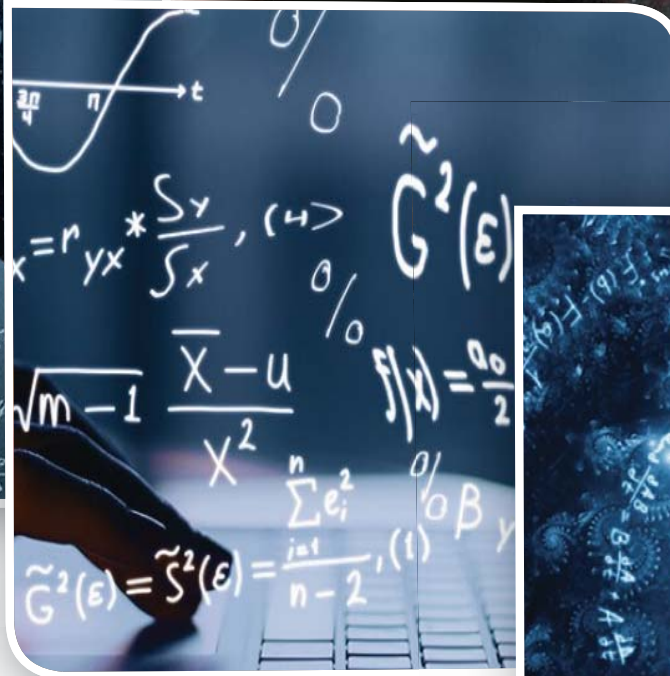

The Department of Applied Mathematics and Statistics (AM&S) of the Institute of Space Technology (IST), Islamabad, is the most productive department of IST in terms of its graduate programs (MS and PhD) with very prominent and most demanded interdisciplinary streams: Computational Fluid Dynamics/Fluid Mechanics, Computational Mathematics, Nonlinear Dynamics, Cryptography, Group Theory and Generalization, Algebra/Algebraic Geometry, and Applied Statistics. We started our journey in 2015. Since the beginning, we have been focusing on our students to make them highly marketable in view of modern challenges. Our graduates have been serving in strategic and non-strategic national and international organizations because of their strong background in computational/simulations and mathematical knowledge and skills. AM&S has experienced, dedicated, and passionate faculty who has a hand in modern research and quality teaching per global educational standards and is contributing to the socio-economic development of Pakistan through impactful research and outcomes-based academic practices. As a result, we are producing scientists and engineers fully equipped with modern mathematics tools with strong understanding towards real world and engineering problems. The AM&S faculty is committed to transferring knowledge to engineering and science students through a modern interdisciplinary curriculum that leads them towards publishing excellent research related to engineering research problems. AM&S faculty have research linkages and collaborations with leading international universities. Through its conducive learning environment, AM&S provides the highest zenith of learning to its students, due to which its PhD and MS students have secured postdoctoral and doctoral positions in highly ranked international institutions. IST has already set an example for other local universities by sending the first student satellite "iCube" into space, which shows our commitment towards making significant contributions towards the vision of IST. The establishment of the department of Mathematics & Statistics will be another quantum leap towards achieving our targets and fulfilling our mission.

Mission Statement

The mission of Department of Applied Mathematics & Statistics is to provide firm foundation to the engineers & scientists working for space science & related technologies in fulfilling the demands of their profession and create a bridge of knowledge and understanding between mathematicians and engineers.

Programs Educational Objectives

After graduation, our students will be equipped not only with advanced mathematical tools but also have strong and practical understanding towards engineering problems. Our graduates will be able to

- Collaborate with Engineers and scientists from industry and academia in research/projects to promote the culture of interdisciplinary research and produce quality research in Pakistan
- Explore the new emerging areas of science and engineering, like, nonlinear dynamics, computational mathematics and cryptography

MS-Mathematics

Department of applied mathematics & statistics is offering MS-mathematics in the following specializations:

Nonlinear Dynamics/ Computational Mathematics/ Analysis & Algebra/ Fluid Mechanics/ Cryptography

Prerequisites

- BS/ BE/ equivalent (16 Years of education) with a strong background in Mathematics/Applied Physics/Space Science or BE in any engineering discipline (with at least C+ in mathematics courses) or MA/MSc. in Mathematics or MA/MSc. in Applied Physics/Space Science (having BSc. with Mathematics A&B) with minimum CGPA =

2.00 out of 4.00 or= 60% marks(where CGPA not available) from HEC and PEC(where applicable)recognized Institute/University or from Foreign Institute/University of good repute.

- GAT (General) conducted by NTS in the relevant field of study with = 50% marksorHAT (General) conducted by HEC in the relevant field of study with = 50% marksorGRE International (General) conducted by ETS, USA, with minimum score as Quantitative: 145, Verbal: 145, Analytical: 3.5

Semester	Courses	Cr. Hr.
01	Core I	03
	Core II	03
	Core III	03
02	Elective I	03
	Elective II	03
	Elective III	03
03	Elective IV	03
	Elective V	03
	Thesis I	03
04	Thesis II	03

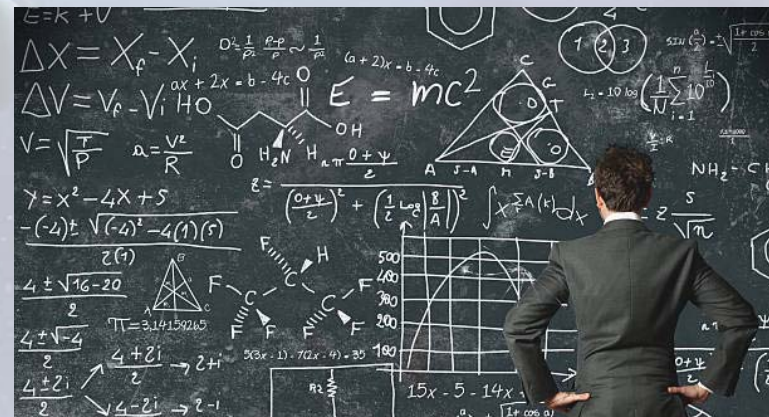

Core Courses

- Advanced Partial Differential Equations
- Advanced Numerical Techniques
- Mathematical Physics
- Numerical Linear Algebra
- Initial and Boundary Value Problems
- Advanced Number Theory
- Advanced Analytical Dynamics
- Integral Equations

Electives

- Nonlinear Dynamics-I
- Nonlinear Dynamics-II
- Numerical Solution to PDEs-I
- Numerical Solution to PDEs-II
- Newtonian Fluid Mechanics
- Non-Newtonian Fluid
- Mechanics
- Magneto-hydro-dynamics (MHD)
- Advanced Probability & Statistics
- Introduction to Cryptography
- Continuous Optimization
- Discrete Optimization
- Methods of Optimization
- Optimization Modeling with AIMMS
- Computer Programming and Softwares for Mathematicians
- Chaotic Cryptography
- Error Correcting Code
- Galois Theory
- Information Hiding
- Introduction to Combinatorics
- Principles and Techniques in Combinatorics
- Noncommutative Cryptography
- Symmetry and Wallpapers Group

- Solid Mechanics-I
- Solid Mechanics-II
- Applied Functional Analysis
- Advanced Real & Complex Analysis
- Convex Analysis
- Applied Evolution Equations
- Algebraic Geometry
- Graph Theory and Group Actions
- Stellar Dynamics
- General Relativity
- Mathematical Modeling & Simulation
- Modern Control Theory
- Introduction to Cryptography
- Acoustics
- Advanced Probability & Statistics
- Bayesian Theory
- Computational Fluid Dynamics
- Heat Transfer and Mass Transfer
- Gravitational Wave Data Analysis
- Operations Research
- Mathematics of Cryptography
- Cryptanalysis
- Elliptic Curves
- Information Theory
- Stochastic Processes
- Finite Element Methods
- Advanced Heat Transfer
- Geostatistics
- Astrostatistics
- Advanced Engineering Mathematics
- Fractional Calculus

Course Description Stellar Dynamics

Potential Theory: Spherical systems, potential density pairs, potentials of spheroidal, ellipsoidal and disk systems, Potential of our galaxy, N-body Codes: Direct summation, tree-codes, particle mesh codes, The Orbits of Stars: Orbits in spherical potential, orbits in axisymmetric potential, orbits in triaxial potential, orbits in elliptical galaxies, numerical orbit integration, Equilibria of Collisionless Systems: Boltzmann equation, Jeans theorems, distribution functions, Jeans and virial equation, Kinetic Theory: Relaxation processes, Fokker Planck approximation, the evolution of spherical stellar systems, Dynamical Friction: Chandrasekhar's formula, applications of dynamical friction, decay of black hole orbits, formation and evolution of binary black holes

Advanced Heat Transfer

Introduction, Heat conduction, Transient and steady state heat conduction, Analytical solutions, Numerical methods, Inverse heat conduction, Heat transfer with phase transformation, Monte Carlo Method, Convective heat transfer, Cooling techniques, Radiation heat transfer, Combined conduction, convection and radiation heat transfer.

Computational Fluid Dynamics

Classification, implicit & explicit methods, iterative & time/space marching schemes, grids, Discretization process, boundary

conditions, aerospace applications, Spectral Element Method, Finite-difference; finite volume methods for solution of Navier- Stokes & Euler equations, Classification of partial differential equations and solution techniques. Truncation errors, stability, conservation and monotonicity, Differencing strategies. Advanced solution algorithms, Grid generation, Construction of complex CFD algorithms, Current applications, Use of CFD codes, CFD Simulation

Mathematical Modeling and Simulation

Introduction to a Dynamic systems and control, modeling and analysis techniques, the fundamentals and applications of control systems, Modeling and Simulation of Dynamic systems based on Bond graph theory, transfer functions, sensitivity and robust control and digital control. Case studies related to motion control system design, electromechanical system design, Stochastic processes applied to control of various types of systems, Markov chains, Queuing theory, Bifurcations, Perturbation Methods, non-homogeneous Equations, Training on Lab View software

Adv Heat and Mass Transfer

Basic Rules of the Heat Conduction and Heat Conductive Equations, Stable Heat Conduction, Instable Heat Conduction, Possessing the Heat Conduction of Moving Boundaries, Basic Concept of the

Heat Radiation, Radiating Heat Transfer of the Solid Surface, Radiation among the Absorption, Radioactivity Medium, Including the Radiating Heat Transformation Convective Heat Transfer in Sealed Cavity of Absorption, Radioactivity Medium. Molecular Diffusion in Liquid, Two-dimension Stable Diffusion, Air Diffusion Coefficient, Conversation Equation, Convection Mass Transfer, Critical Mass Transformation

Non-Newtonian Fluid Mechanics

Basic review of fluid properties and basic flow equations, (Navier-Stokes' equations etc.), laminar flows, Turbulent flows, Compressible and Incompressible flows, Partial differential equations governing the conservation of mass, Momentum and energy of Newtonian fluids are derived. Dimensional analysis used to simplify the governing equations, low Reynolds number flow, Stokes flow, high Reynolds number laminar flow, Boundary layer separation phenomena and approximations to the governing equations, laminar stability and transition to turbulent boundary layer conditions

Advanced Partial Differential Equations

Definition of PDE, Solution of PDEs and principle of superposition, Boundary conditions and their types, Homogeneous PDEs with constant coefficient and separation of variables, Holomorphic functions,

Classification of second order linear PDEs, The Heat equation and diffusion equation, Wave equation and vibrating string, Initial and boundary conditions for heat and wave equations, Laplace's Equation, Solutions of Heat, wave and Laplace's equations by separation of variables, Fourier transform and properties, Convolution theorem for Fourier transform, Solution of PDEs by Fourier transform, Laplace transform and its properties Convolution theorem for Laplace transform, Laplace transform of Heaviside unit step and Direct Delta functions, Solutions of partial differential equations by Laplace transform method Green's function and its properties, Method of Green's function, Nonlinear partial differential equations, Method of characteristics, Solution of nonlinear partial differential equations by method of characteristics

Magnetohydrodynamics

Equations of electrodynamics, Equations of Fluid Dynamics, Ohm's law equations of magnetohydrodynamics, Motion of a viscous electrically conducting fluid with linear current flow, steady state motion along a magnetic field, wave motion of an ideal fluid, Effects of molecular structure, Currents in a fully ionized gas, partially ionized gases, interstellar fields, dissipation in hot and cool clouds, Kinematics of MHD: Advection and Diffusion of a Magnetic field, Low-Magnetic Reynold's number

Newtonian Fluid Mechanics

Fluids and flows, Viscosity, Newton's law of viscosity, Classification of fluids, Types of flows, Static equation, Euler's equation, Conservation laws, Flux, Fourier law of conduction, Fick's laws, Bernoulli Equation, Navier-Stokes equation and exact solutions Dimensional analysis and Similitude, Boundary layer approximations and governing equations

Initial and Boundary Value Problems

Green's function method with applications to wave-propagation, regular and singular perturbation techniques with applications. Variational methods. A survey of transform techniques; Wiener-Hopf technique with applications to diffraction problems, Asymptotic expansion integrals and properties, Methods of averaging, Convergence of mathematical solutions

General Relativity

Flat Spacetime, Vectors and Dual Vectors, Tensors. Special Relativity, Energy and Momentum, Conserved Currents, Stress Energy Tensor, Transformation Law for Tensors, Metric in a Curved Space, Orthonormal and Coordinate Bases; Derivatives; Tensor Densities; Differential Forms and Integration, Gauge/ Coordinate Transformations. Metric in a Curved Space, Orthonormal and Coordinate Bases; Derivatives; Tensor Densities; Differential Forms and Integration,

Gauge/Coordinate Transformations. Connection and Curvature, Geodesics, Introduction to Curvature, Geodesic Deviation, Bianchi Identity, Killing Vectors and Symmetries, Einstein's Equation and Gravitation, Cosmological Constant, Hilbert Action.

Weak Field/Linearized General Relativity, Gauge Invariant Characterization of Gravitational Degrees of Freedom. Spacetime of an Isolated Weakly Gravitating Body, Gravitational Waves, Gravitational Lensing, Cosmology, Friedmann-Robertson-Walker Solution; Distance Measures and Redshift, Schwarzschild Solution, Birkhoff's Theorem, Metric of a Spherical "Star", Black Holes, Collapse to Black Hole; Orbits of a Black Hole, Kerr and Reissner-Nordstrom Solutions, Advanced Topics and Current Research in General Relativity

Gravitational Waves and Data Analysis

Prior, likelihood, posterior, MAP, ML, Starting from simple examples of single and multiple sinusoid and chirp mass signals, auto-covariance/-correlation, spectrum, white noise, coloured noise, spectrum estimation, Fourier methods, windowing, Marginal likelihood, evidence, Bayes factor, likelihood ratio test, Neyman-Pearson Lemma, generalized likelihood ratio test, multiple testing, trials factor, "look-elsewhere-effect", Lindley's paradox,

detection/false-alarm probabilities sensitivity/specificity), ROC curve, non-detection limits, Common posterior computations, pseudo random number generation, inverse method Gibbs sampler, Metropolis sampler, Metropolis-Hastings sampler, simulated, annealing, parallel tempering, nested sampling

Modern Control Theory

What Is Mathematical Control Theory? Proportional-Derivative Control, State-Space and Spectrum Assignment Outputs and Dynamic Feedback Dealing with Nonlinearity, I/O Behaviors, Discrete-Time Linear Discrete-Time Systems Smooth Discrete-Time Systems Continuous-Time, Linear Continuous-Time Systems Linearizations Compute Differentials Sampling, Volterra Expansions, Lie Brackets, Lie Algebras and Flows Accessibility Rank Condition Ad, Distributions, and Frobenius' Theorem Necessity of Accessibility Rank Condition, Constant Linear Feedback, Feedback Equivalence Feedback Linearization, Disturbance Rejection and Invariance, Stability and Other Asymptotic Notions Unstable and Stable Modes, Lyapunov and Control-Lyapunov Functions, Linearization Principle for Stability, Introduction to Nonlinear Stabilization, Observers and Detectability, Dynamic Feedback External Stability for Linear Systems, Frequency-Domain Considerations, Parametrization of Stabilizers, Dynamic Programming, Linear Systems with Quadratic Cost,

Tracking and Kalman Filtering Infinite-Time (Steady-State) Problem Nonlinear Stabilizing Optimal Controls, Review of Smooth Dependence Unconstrained Controls Excursion into the Calculus of Variations Gradient-Based Numerical Methods Constrained Controls: Minimum Principle Notes and Comments Optimality: Minimum-Time for Linear Systems Maximum Principle for Time-Optimality and its applications

Introduction to Cryptography

Background and overview, One-time encryption using stream ciphers, Semantic security, Block ciphers and pseudorandom functions, Chosen plaintext security and modes of operation, The DES and AES block ciphers, Message integrity. CBC-MAC, HMAC, PMAC, and CW-MAC, Collision resistant hashing, Authenticated encryption. CCM, GCM, TLS, and IPsec. Key derivation functions, Odds and ends: deterministic encryption, non-expanding encryption, and format preserving encryption, Basic key exchange: Diffie-Hellman, RSA and Merkle puzzles, A crash course in computational number theory, Number theoretic hardness assumptions, Public key encryption, Trapdoor permutations and RSA, The ElGamal system and variants, Digital signatures and certificates, Identification protocols, Authenticated key exchange and TLS key exchange, Zero knowledge protocols and proofs of knowledge, Privacy mechanisms: group

signatures and credential systems, Private information retrieval and oblivious transfer, Two party computation: Yao's protocol and applications, Elliptic curve cryptography, Quantum computing, Pairing-based cryptography, Lattice-based cryptography, Fully homomorphic encryption

Advanced Number Theory

Divisors; Bezeout's identity; LCM, Linear Diophantine equations, Prime numbers and prime-power factorizations; Distribution of primes; Primality-testing and factorization, Modular arithmetic; Linear congruencies; An extension of Chinese Remainder Theorem; The arithmetic of \mathbb{Z}_p ; Solving congruence's mod n ; Euler's function. The group U_n ; Primitive roots; The group U_n , n is power of odd prime and n is power of 2. Quadratic congruences; The group of quadratic residues; The Legendre symbol, Quadratic reciprocity, Definition and examples; perfect numbers; The Modius Inversion formula., Random integers, Dirichlet series, Euler products, Sums of two Squares; The Gaussian integers; Sums of three Squares; Sums of four Squares, The problem; Pythagorean Theorem; Pythagorean triples; The case $n=4$; Odd prime exponents. Rotating Hoop, Imperfect Bifurcations and Catastrophes, Insect Outbreak, Introduction, Examples and Definitions, Uniform Oscillator, Nonuniform Oscillator, Over damped Pendulum, Fireflies, Superconducting Josephson Junctions, Classification

of Linear Systems, Love Affairs, Phase Portraits, Existence, Uniqueness, and Topological Consequences, Fixed Points and Linearization, Rabbit versus Sheep, Conservative Systems, Reversible Systems, Pendulum, Index Theory, Introduction, Examples, Ruling Out Closed Orbits, Poincare-Bendixson Theorem, Lienard Systems, Relaxation Oscillators, Weakly Nonlinear Oscillators

Nonlinear Dynamics-II

Saddle-Node, Transcritical and Pitchfork Bifurcations, Hopf Bifurcations, Oscillating Chemical Reactions, Global Bifurcations of Cycles, Hysteresis in the Driven Pendulum and Josephson Junction, Coupled Oscillators and Quasiperiodicity, Poincare Maps, A Chaotic Waterwheel, Simple Properties of the Lorenz Equations, Chaos on a Strange Attractor, Lorenz Map, Exploring Parameter Space, Using Chaos to Send Secret Messages, Introduction, Fixed Points and Cobwebs, Logistic Map: Numerics, Logistic Map: Analysis, Periodic Windows, Liapunov Exponent, Universality and Experiments, Renormalization, Introduction, Countable and Uncountable Sets, Cantor Set, Dimension of Self-Similar Fractals, Box Dimension, Pointwise and Coorelation Dimensions, The Simplest Examples, Henon Map, Rossler System, Chemical Chaos and Attractor Reconstruction, Forced Double-well Oscillator

Operations Research

Introduction to Operations Research (OR): Introduction to Foundation mathematics and statistics, Linear Programming (LP), LP and allocation of resources, LP definition, Linearity requirement, Maximization Then Minimization problems., Graphical LP Minimization solution, Introduction, Simplex method definition, formulating the, Simplex model, Linear Programming – Simplex Method for Maximizing, Simplex maximizing example for similar limitations, Mixed limitations, Example containing mixed constraints, Minimization example for similar limitations, Sensitivity Analysis: Changes in Objective Function, Changes in RHS, The Transportation Model, Basic Assumptions, Solution Methods: Feasible Solution: The Northwest Method, The Lowest Cost Method, Optimal Solution: The Stepping Stone Method, Modified; Distribution (MODI) Method, The Assignment Model:- Basic Assumptions, Solution Methods:-Different Combinations Method, Short-Cut Method (Hungarian Method), MSPT:- The Dijkstra algorithm, and Floyd's Algorithm {Shortest Route Algorithm}

Numerical Linear Algebra

Matrix-Vector Multiplication, Orthogonal Vectors and Matrices, Norms, The Singular Value Decomposition, Projectors, QR factorization, Gram-Schmidt

Orthogonalization, MATLAB, Householder Triangularization, Least Square Problems, Conditioning and condition numbers, Floating Point Arithmetic, Stability, Stability of Householder Triangularization, Stability of Back substitution, Condition of Least Square Problems, Gaussian Elimination, Pivoting, Stability of Gaussian Elimination, Cholesky Factorization, Eigenvalues Problems, Overview of Eigenvalues Algorithms, Reduction of Hessen berg or Traditional Form Raleigh Quotient, Inverse Iteration, Overview of Iterative methods, The Arnoldi Iteration, How Arnoldi Locates Eigenvalues, GMRES, The Lanczos Iteration

Acoustics

Fundamentals of vibrations, Energy of vibration, damped and free oscillations, transient response of an oscillator. Vibrations of strings, Membrances and plates, Forced vibrations, Normal modes, Acoustic waves equation and its solution, Equation of state, Equation of cont, Euler's equation, Linearized wave equation, Speed of sound in fluid, Energy density, Acoustic intensity, Specific acoustic impedance, Spherical waves, Transmission; Transmission from one fluid to another (Normal incidence) reflection at a surface of

Mathematics of Cryptography

Historic background Cryptographic algorithms Types of attacks used to

break cryptosystems, Modular arithmetic Greatest common divisors Congruences Chinese Remainder Theorem Primitive roots Finite fields, Substitution ciphers Polyalphabetic ciphers Permutation ciphers, One-way hash functions and properties Secure Hash Algorithm Birthday attacks, Applications to information assurance and cyber security

Cryptanalysis

Introduction to cryptanalysis, Monographic substitution systems, Monoalphabetic unilateral substitution systems using standard cipher alphabets, Monoalphabetic unilateral substitution systems using mixed cipher alphabets, Monoalphabetic multilateral substitution systems part three - polygraphic substitution systems, Characteristics of polygraphic substitution systems, Solution of polygraphic substitution systems, Periodic polyalphabetic substitution systems, Solution of periodic polyalphabetic systems, A periodic polyalphabetic ciphers, part five - transposition systems, Types of transposition systems, Solution of numerically-keyed columnar transposition ciphers, Transposition special solutions part six - analysis of code systems, Types of code systems, Analysis of syllabary spelling, Frequency distributions of English digraphs, Frequency distributions of English trigraphs, Frequency distributions of English tetragraphs

Advanced Probability & Statistics

Overview of the basic concepts in statistics and probability Tests based on normal distribution, Tests of characteristics of a single distribution; Tests of characteristics of two distributions Tests based on Student's t-distribution, Tests of characteristics of a single distribution; Tests of characteristics of two distributions, Tests of characteristics of two distributions; Certain chi-square tests, Certain chi-square tests; Simple linear regression model, Simple linear regression model, linear correlation; Inferences in the regression model and correlation, More on correlation and Inferences, Adequacy of the fitted model; Multiple linear regression, Multiple linear regression, Multiple linear regression; More on multiple regression, Tests based on F-Distribution, Inferences on variance, Analysis of variance, One-way classification, Two-way classifications, analysis of covariance, Experimental designs, Completely randomized design, Randomized complete block designs

Bayesian Theory

Bayes' theorem: discrete case, Likelihood-based functions, Bayes' theorem: continuous case Conjugate examples: Binomial, Normal, Poisson, and Gamma, data, Exchangeability, Sequential Learning, Likelihood Principle, Conditionality Principle, Sufficiency Principle, Stopping Rule Principle Decision-

Theoretic Foundations of Statistical Inference, Decision Rules, Loss Functions, Risks, Bayes Estimators Under Standard Loss Functions, Minimax Rules, Admissible Rules, Unbiasedness Subjective priors, Conjugate priors, Noninformative priors, Empirical Bayes priors, Hierarchical priors, Numerical integration, Asymptotic approximations Simple simulation: inverse transform, rejection and mixture method, Stochastic Simulation: rejection and SIR, Metropolis-Hastings algorithm, Practical Implementation Issues, Markov Chain Theory Derivation of the MH Algorithm, Gibbs sampler Adaptive rejection sampling, Slice sampling, Introduction and WinBUGS handouts, Bayesian Linear Regression, Model Checking, Model Comparison via DIC, Analysis of Variance, Generalized Linear Models Hierarchical Models, State-Space Modelling of Time Series, Multivariate Modelling Using Copulas, Bayes factors, Bayesian p-values, Posterior distribution of the deviance

Nonlinear Dynamics-I

An overview to Chaos, Fractals, and Dynamics, Capsule History of Dynamics, The Importance of Being Nonlinear, A Dynamical View of the World, A Geometric Way of Thinking, Fixed Points and Stability, Population Growth, Linear Stability Analysis, Existence and Uniqueness, Impossibility of Oscillations, Potentials, Solving Equations on the Computer, Introduction, Saddle-Node Bifurcation, Transcritical Bifurcation,

Laser Threshold, Pitchfork Bifurcation, Overdamped Bead on a solid (normal and oblique incidence). Absorption and attenuation of sound waves in fluids, Pipes Cavities, Wave guides; Underwater acoustics

Advance Numerical Techniques

Bisection Method, Secant Method, Iteration Method, Regula False Method, Newton Raphson Method, Gauss Elimination Method, Inversion of a matrix using Gauss Elimination Method, Method of triangularization, Crout's Method, Gauss Jacobi & Gauss Seidel Method, Relaxation Method, QR-decomposition, Solution of Systems of Non-linear Equations, Divided differences
Newton's divided difference, Lagrange's Interpolation formula, Gregory Newton forward and backward Interpolation formula, Gauss forward and backward Interpolation formula, Natural splines, Parabolic Runout spline, Cubic Runout splines, Curve fitting with splines, Newton's forward & backward differences to compute derivatives, Derivatives using Stirlings formula, Trapezoidal rule, Truncation error, Simpson's rule, Weddle's rule, Newton-Cote's formula, Boole's rule, Optimization, Power Method, Dominant Eigen values & Eigen vectors, Power series approximations, Solutions by Taylor series, Picard's Method of successive approximations, Euler's Method, Improved & Modified Euler Method, Runge Kutta Methods, Predictor corrector Methods,

Numerical solutions of Elliptic, Parabolic, Hyperbolic type equations, Crank-Nicholson difference method, Relaxation method to solve differential equation

Numerical Solution of PDE-I

Classification of PDEs, canonical forms and well-posed problems, behavior of solutions, characteristics. An introduction to finite difference methods, Basics of Finite Difference Approximations, Derivation of finite difference approximations, Consistency, stability for difference approximations, CFL condition, The Lax Theorem. Matrix and Fourier stability analysis, Parabolic Equations, Explicit and implicit methods for the heat equation, direction splitting and ADI schemes, steady convection-diffusion equations, Hyperbolic Equations, transient convection-diffusion equation, Finite difference methods for the wave equation and high-order methods. Iterative solution of linear algebraic equations, Thomas algorithm for implicit schemes, and Finite difference in higher space dimensions

Numerical Solution of PDE-II

First-order nonlinear equations, quasi-linear and conservation forms, Characteristics, shock waves and contact discontinuities, Finite volume methods, Godunov methods and Riemann solvers, high resolution schemes, Dirichlet and Neumann problems, solvability, Direct vs. iterative methods of solution, line by line implementation of thomas

algorithm, Relaxation and multigrid methods, Multistep schemes, stability of general multistep schemes, Dispersion and dissipation of numerical schemes, Group velocity and wavepackets in numerical schemes, Numerical solution of systems of hyperbolic PDEs; multilevel schemes; stability and convergence. Introduction to finite element method, finite element method for elliptic and parabolic equations, Recent development in numerical methods

Elliptic Curves

Cryptography basics, Public-key cryptography, Finite Field Arithmetic, Binary field arithmetic, Elliptic Curve Arithmetic, Introduction to Elliptic Curves, Point representation and the group law, Curves with efficiently computable endomorphism, Point multiplication using halving, Cryptographic Protocols, The elliptic curve discrete logarithm problem, Types of Attacks of Elliptic Curves, Domain parameters, Key pairs, Signature schemes, Public-key encryption, Key establishment

Stochastic Processes

Review of probability and random variables, random walk, Stochastic Processes – definition, methods of description, time averaging and ergodicity, continuity, integration and differentiation, autocorrelation, power spectral density, response of linear systems to stochastic inputs, classes of stochastic processes, Shot noise, thermal noise, point processes, Markov processes,

Gaussian processes, Mean square error filtering, orthogonality, smoothing, prediction, stochastic gradient algorithm, innovations, Weiner filter, Kalman filter, queuing theory, Poisson arrivals

Continuous Optimization

Introduction to mathematical optimization, duality (Lagrange and saddle point), Optimality Conditions (KKT-theory), Regularity condition (such as Slater's conditions), Convex optimization, introduction to semi-definite programming

Discrete Optimization

The course is an introduction to discrete optimization problems and solution techniques. The topic includes: Shortest path problem, Max flow-min cut problem, traveling salesman, matching, integer optimization, methods for integer optimization (cutting plane methods), introduction to complexity

Methods in Optimization

Simplex methods, Steepest Descent and Conjugate Gradient Methods, Interior point method for convex optimization, Gradient free methods (Nelder–Mead Simplex Algorithm), search methods (bisection search and genetic algorithm)

Chaotic Cryptography

Basics of cryptography and chaos, basic terminologies of cryptography and chaos, symmetric and asymmetric key cryptographic techniques, discrete chaotic

systems, continuous chaotic systems, connection between chaos and cryptography, utilizing chaos in private/secret cryptography, applying chaos in public key cryptography, chaotic orthogonal polynomials, public key cryptosystems based orthogonal polynomials, application of orthogonal polynomials in digital signatures and registration.

Error Correcting Codes

Introduction to coding theory, block codes and maximum likelihood decoding, decoding principle, hamming weight and distance, error correction vs detection, linear block codes, generator matrix, parity-check matrix, hamming codes, error-correcting capability of a linear code, the standard array and syndrome decoding of a linear code, binary cyclic codes, description of cyclic codes, encoding with (n-k)-stage shift register, syndrome calculations and error detection, a general decoder for cyclic codes, shortening and extension of cyclic codes, Galois fields, bch codes, reed Muller codes, simplex codes, relationship between simplex and reed Muller codes, relation between hamming and reed Muller codes, the trellis representation and properties of block codes, decoding of block codes.

Galois Theory

Introduction to extension fields, algebraic extensions, finite fields, the basic isomorphism of algebraic field theory, automorphism and fields, the

isomorphism extension theorem, splitting fields, separable extensions - Galois theory, illustrations of Galois theory.

Information Hiding

The goals of steganography and watermarking, typical cover objects, embedded information, steganography against cryptography, the main attacks on steganography, criteria of steganography efficiency, embedding in the least significant bits, the main detection algorithms, real world of steganography, spread spectrum based steganography, linguistic steganography, graphic steganography, network steganography, ideal and almost ideal steganography, leibler-kullback divergence, Bhattacharya distance, model based steganography, perturbed quantization steganography, hugo project, steganography based on noisy channels, blind steganalysis, criteria of watermarking systems efficiency, the main applications of watermarking, watermarking embedding and extraction technique, concatenated watermarking systems, embedding with informed encoder, sophisticated attacks on watermarking, coalition attacks on watermarking, system attacks on watermarking, content authentication by watermarking, a peculiarity of audio watermarking, capacity of steganography and watermarking systems.

Principles and Techniques in Combinatorics

Basic counting principles, permutations, combinations, the injective and bijective principles, arrangements and selections with repetitions, graphs in combinatorics, the binomial theorem, combinatorial identities, properties of binomial coefficients, multinomial coefficients, the multinomial theorem, the pigeonhole principle, examples, ramsay numbers, the principle of inclusion and exclusion, generalization, integer solutions, surjective mapping, stirling numbers of the second kind, the sieve of eratostheries, Euler ϕ -function, the probleme des manages, ordinary generating functions, partition of integers, exponential generating functions, linear homogeneous recurrence relations, algebraic solutions of linear recurrence relations and constant functions, the method of generating functions, a nonlinear recurrence relation and catalpa numbers.

Non-Commutative Cryptography

Background on groups and cryptography, background on combinatorial group theory, non-commutative cryptography, canonical non-commutative cryptography, platform groups and cryptographic protocols, open problems in nonabelian group based cryptography.

Symmetry and Wallpapers Groups

Symmetry groups and color patterns, permutation groups, groups of symmetries, colorings and color patterns, action of a group, pattern inventory, generating functions for non-isomorphic graphs, wallpaper pattern groups.

Convex Analysis

Convex sets and functions, epigraphs and level sets of convex functions, relative interiors, closures, projection and separation, the projector operator and its uniqueness, separating hyperplanes, supporting hyperplanes, and their consequences, structure of convex sets, faces, extreme points, recession cones, and their properties, exposed and non-exposed faces, decomposition of convex sets, conical approximations, tangent cones, normal cones, and their properties, support functions. sublinear functions, support functions of a nonempty set, correspondence between sub-linear functions and convex sets, conjugacy in convex analysis, the convex conjugate of a function, calculus rules, conjugate duality and its applications in optimization, infinite dimensional convex analysis, analogues of some of the above results for general vector spaces, including the hahn-banach theorem, introduction to convex geometry, the space of convex bodies, mixed volumes.

blaschke selection theorem and the brunn-minkowski inequality.

Graph Theory and Group Actions

Study of the structure and properties of graphs and their usefulness within group theory and in other fields in general. Also investigate several properties of groups through their finite presentations and actions, introduction to graph theory, connectivity, Eulerian graphs, Hamiltonian graphs, counting trees, planar graphs, Euler's formula, graph coloring, formal theory of presentations, survey of theory of group actions, applications of group actions, transitivity and k-transitivity, primitivity, finite fields and their extensions, projective spaces and their groups, Tietze transformation, automorphism group, systematic enumeration of cosets, Cayley and Schreier's coset graphs, graphs for group actions, coset diagrams.

Solid Mechanics-I

Introduction to Solid Mechanics, Statics or Rigid Bodies, The Fundamental Concepts and Principles of Mechanics, The Statics of Particles, The Statics of Rigid Bodies, Stress and Strain, Surface and Contact Stress, Body Forces, Internal Stress, Equilibrium of Stress, Stress Transformation: Further Aspects, Plane Stress, Stress Boundary Conditions: Continued, Strain, Plane Strain, Volumetric Strain, Material Behavior and Mathematical Modeling, Mechanics

Modeling, The Response of Real Materials, Material Models, The Continuum, Linear Elasticity, The Linear Elastic Model, Homogeneous Problems in Linear Elasticity, Anisotropic Elasticity, Engineering Applications of Elasticity, One Dimensional Axial Deformations, Torsion, Pressure Vessels, Beams, Buckling, Energy and Virtual Work, Energy in Deforming Materials, Elastic Strain Energy, Complementary Energy, Strain Energy Potentials, Virtual Work, The Principle of Minimum Potential Energy, Applications to Engineering problems and Modeling.

Solid Mechanics-II

Concepts in Continuum Mechanics, Tensor and Contraction operations, Material Behavior and Mathematical Modeling, Continuum Material Models and real world applications, Theory of Elastoplasticity, Applications of Elastoplasticity, Theory of Plasticity, Applications of Plasticity, Energy Methods in Material Modeling and Simulations, Intro to Crystalline Plasticity.

Applied Functional Analysis

Complete metric spaces, contraction mapping theorem, Banach spaces, completion, function spaces, linear operators, inverses, approximate solution to operator equations, Frechet derivatives, Newton-Kantorovich method, Schauder fixed point theorem, Hilbert spaces, projections, generalized Fourier series, Riesz representation theorem,

Ritz method, generalized solutions, Sobolev spaces, Lax-Milgram theorem, compact operators, spectral theorem.

Advanced Real and Complex Analysis

Review of real number system, limiting behavior of infinite sequences and series on the real line and the complex plane, point-wise and uniform convergence, power series leading into the theory of analytic functions and complex analysis, elementary functions on the complex plane, the Cauchy integral theorem, Cauchy integral formula, residues and related topics with applications to real integrals, hypergeometric functions.

Applied Evolution Equations

Introduction to PDE's, Linear and nonlinear PDE's, Introduction to evolution equation, Dissipative dynamics, Basic Function spaces, Fourier series, Dissipative PDE's, The KPP equation, The Allen-Cahn equation, Fourier analysis, The Burgers equation, Canonical modulation equations, The NLS equation, The KdV equation, The GL equation, Reaction Diffusion systems, Wave packets and the NLS equation, Pulse dynamics in photonic crystals.

Algebraic Geometry

Affine and Projective Varieties, Hypersurfaces, Analytic Subvarieties and Submanifolds, Regular Functions and Maps Cones, The

Zariski Topology, Regular Functions on an Affine Variety Cones Quadrics Projections, Projections, Families and Parameter Spaces Algebraic Groups, The General Linear Group, The Orthogonal Group, The Symplectic Group, Group Actions, Quotients, Quotients of Projective Varieties by Finite Groups.

Finite Element Methods

Introduction to Finite Element Methods (FEM), Mathematical preliminaries, Strong and weak form of FEM, Truss Analysis, Variational approaches & weighted residual formulations to FEM, General approach to structure analysis, continuous shape functions, Stress analysis for one & two-dimensional problems of structures, problem formulation and solution for 1D, 2D, 3D, in-Plane and Eigen value problems, beam analysis, introduction to coupled problems in FEM, Dynamical Structural Analysis and ANSYS/ COMSO/ MULTIPHYSICS for analysis.

Computational Electromagnetic

Basic electromagnetic theory, Maxwell's equations, Development of boundary conditions for electromagnetic equations, Solution methods for electromagnetic equations, Review of iterative schemes for system of linear and non-linear equations, Basics of programming, Array, functions, loops and conditional statements, Computer programs development,

Electrostatic boundary value problems, Electric and magnetic potential Poisson equations and their analysis with numerical solutions, Magnetization, types of magnetization and related concepts.

Advance Topics in Fluid Mechanics

Brief review of recent developments in fluid mechanics, Review on modification of conservation laws of fluid mechanics, Modified second laws Fick's law, Modified mass transport equation in higher dimensions, Plasma and its basic equations in presence of magnetic field, Heat transfer in Plasma flow, Mass Transfer in plasma, Review and reproduction of most recent published articles for fluid flows, Review and reproduction of research articles on simultaneous transport of heat and mass in plasma.

Advance Computational Fluid Dynamics

Conservation laws, Differential and integral forms of the general transport equations, classification of fluid flow equations, Finite difference methods (implicit, explicit and multistep schemes) and their stability, Solutions of finite difference equations, Vorticity-stream function formulation, cavity flow, heat transfer in cavity flow, Finite volume method, Finite volume method for one, two and three-dimensional diffusion problems, steady convection-diffusion problems, Conservativeness, boundedness and

transportiveness of difference schemes, Advection problems, The upwind differencing scheme, The hybrid difference scheme, The power law difference scheme, The Quick differencing scheme, TVD schemes, Solution algorithms for pressure velocity coupling (SIMPLE, SIMPLER, SIMPLEC and PISO), Finite volume method for unsteady flows, CFD modeling and commercial codes, Flow problems and finite element methods.

Nonlinear Systems

Introduction to nonlinear systems and control, Phase Plane Analysis, Fundamentals of Lyapunov Theory, Advanced Stability Theory, Hamiltonian Systems on Linear Symplectic Spaces, Feedback Linearization, Sliding Control.

Research Topics in Nonlinear Dynamics

This course will cover most recent research topics in the field of nonlinear dynamics through literature

Topics in Computational Mathematics

Introduction, Fundamental of Tensor Calculus, Tensor theory in Continuum Mechanics, Non-classical continuum theories (Higher order continuum theories), Modeling and Simulations using Higher order continuum theories (Computational methods in Cosserat continuum), Computational techniques for engineering problems.

Mathematical Physics

Vector analysis, Green's, Stokes' and Gauss' divergence theorems, vector analysis in curvilinear coordinates, tensor analysis, determinants and matrices, infinite series, functions of complex variables, C-R equations, Cauchy's Integral formula, Laurent series, Frobenius series, ordinary and partial differential equations, Green's function techniques.

Fractional Calculus

This course specially designed for MS/PhD students. The main topics which are covered are as follow: Fractional-order Derivative, types of fractional derivative and integrals, Mittag Leffler Function, application of Fractional Derivative, Laplace Transform, Power series Method, Adomian's Decomposition Method, Variational Iteration Method, Homotopy Perturbation Method, Application of Modified R-L Derivative.

PhD in Mathematics Eligibility Criteria

- MS/ M.Phil/ equivalent (18 Years of education) with a strong background in relevant discipline with minimum CGPA 3.00 out of 4.00 or First Division (where CGPA not available) from HEC/PEC recognized Institute/University or from Foreign Institute/University of good repute
- Valid GAT (General) conducted by NTS in the relevant field of study with $\geq 60\%$ score or Valid HAT administered by the Education Testing Council (ETC-HEC) in the relevant field of study with $\geq 60\%$ score or GRE International (General) conducted by ETS, USA, with minimum score as Quantitative: 145, Verbal: 145, Analytical: 3.5 or Valid GAT (Subject) conducted by NTS in the relevant field of study with $\geq 60\%$ score or Minimum 60% marks in test equivalent to GRE/ HAT General/ Subject conducted by the Higher Education Institution (HEI). The IST institutional code to receive GRE scores is 1758.

Research Prerequisites

- Research proposal (intended research work during PhD) approved by Departmental Board of Graduate studies

(DBGS)*. *DBGS committee comprises members as per IST policy

- A PhD candidate will be required to give a presentation to DBGS related to his/her research proposal before his/her research is finalized

Course work

Minimum 18 credit hours of course work must be undertaken with at least CGPA of 3.0 out of band 4.0 Migration/Transfer of the courses from other Universities/Institutes is allowed as per IST Migration/Transfer policy.

The list of six PhD courses must have been approved by DBGS. The DBGS will also assign him/her a supervisor as per IST Policy in vogue after listening to his/her presentation.

Comprehensive Examination

Comprehensive examination is conducted after successful completion of PhD course work. Student will be required to appear in comprehensive exam within year after completion of course work. Schedule and structure of this exam will be as per IST policy. Students, who fail in comprehensive exam, will be allowed only once to reappear, failing which, the PhD-studentship will be terminated from IST

Synopsis

After successful passing of the comprehensive exam, a student will write his/ her synopsis paper and present/ defend his/ her synopsis in front of DBGS. The minimum passing marks of synopsis are 60%.

Research Work

24 credit hours of research work spanning over at least two years through continuous registration in Thesis-I, Thesis-II, Thesis-III, and Thesis-IV of 6 credits each One research publications in journal(s) of W-category, defined by HEC, and these publications should at least be ranked as Honorable by Journal Quality Ranking System (JQRS) (<http://jqrs.ist.edu.pk>), defined by IST. It is important to mention that only W-category journals of HEC are ranked in JQRS. The publications topic(s) should be relevant to the PhD specialization area of research

PhD Thesis

On the successful completion of research work. The student will write a detailed report/ thesis about his/ her research outcome. This thesis/ report will then be recommended by DGBS and GSRC. Moreover, A plagiarism check will also be conducted and endorsed by the respective supervisor as per HEC policy. After getting a clearance certificate, this thesis will be sent to the international reviewer of technologically advanced countries (see guidelines of HEC for the

advance countries list) and national expert of the relevant research area. An open defense of the thesis after positive feedback from foreign and national expert will be arranged. this defense will be conducted in the presence of defense committee and general audience. A viva meeting between candidate and defense committee to discuss corrections required in the dissertation. The candidate will be informed about the outcome of defense

Award of PhD Degree

A PhD degree will be awarded to the students after completion the following requirements;

- Successful completion of course work
- Successful completion of comprehensive exam
- Successful presentation/defense of synopsis
- One research publications in HJRS indexed journals
- Evaluation of thesis by the national or international experts
- At least four research presentations of each thesis phase during research work
- Successfully defense of the

thesis in front of Defense Committee Approval by Graduate Studies & Research Council (GSRC)

PhD Courses

- Advance Computational Fluid Dynamics
- Computational Electromagnetics
- Topics in Computational Mathematics
- Nonlinear Systems
- Research Topics in Nonlinear Dynamics
- Advance Topics in Fluid Dynamics
- Advanced Partial Differential Equations
- Non-newtonian Fluid Mechanics
- Heat Transfer and Mass Transfer
- Mathematical Modeling and Simulation
- Computational Fluid Dynamics
- Stellar Dynamics
- Numerical Solution of PDE-I
- Advance Numerical Techniques
- Numerical Solution of PDE-II
- Numerical Linear Algebra
- Operations Research
- Nonlinear Dynamics-II
- Nonlinear Dynamics-I
- Mathematics of Cryptography
- Advanced Number Theory
- Introduction to Cryptography
- Modern Control Theory
- Gravitational Waves and Data Analysis
- General Relativity
- Newtonian Fluid Mechanics
- Initial and Boundary Value Problems
- Magnetohydrodynamics
- Stochastic Processes
- Elliptic Curves
- Acoustics
- Continuous Optimization
- Discrete Optimization
- Methods in Optimization
- Chaotic Cryptography
- Error Correcting Code
- Finite Element Methods
- Galois Theory
- Information Hiding
- Introduction to Combinatorics
- Noncommutative Cryptography
- Symmetry and Wallpapers Group
- Solid Mechanics-I
- Solid Mechanics-II
- Applied Functional Analysis
- Advanced Real & Complex Analysis
- Convex Analysis
- Applied Evolution Equations
- Algebraic Geometry
- Graph Theory and Group Actions

Note: Changes in PhD policy can be made to keep it in compliance with HEC guidelines and rules & regulations. These can be issued without any prior notice and shall be applicable to all students instantly.

Office of Research, Innovation and Commercialization

Office of Research, Innovation and Commercialization (ORIC) was established at Institute of Space Technology (IST) under the aegis of Higher Education Commission (HEC) in June 2011.

ORIC is commissioned with to manage and advance the university's strategic initiatives around Research & Development (R&D), innovation and commercialization. ORIC has been creating an enabling environment for IST students, faculty and researchers to conduct world-class research, accomplish Industry-focused projects, translate academic research into products and services, and to commercialize the intellectual property.

Team ORIC envisions to transform IST into a Research University. We strive to make IST an elite research-intensive university by fostering multidisciplinary R&D in the fields of Engineering, Science and Technology. As professionals, we are committed to create a cohesive university-wide environment of research excellence in order to support and commercialize cutting-edge research outputs of our students, faculty and researchers; those are responsive to the regional and national emerging needs of the country.



The office oversees a variety of functional areas, such as, Research Management, University-industry Linkages, Intellectual Property Rights, Business Incubation and Technology Transfer.

Research Management

Research Management section strives to promote innovative research at IST to address the strategic and national problems/issues in engineering science and technology. In this regard faculty members/researchers and students are facilitated to avail funding opportunities for R&D initiatives and execution of Joint Research Projects (JRPs). Moreover, this section is responsible for:

- Promoting innovative research to address strategic/national issues in Engineering, Science & Technology
- Extending support regarding proposal development, pre-award and post-award formalities across the lifecycle of a research project(s)
- Providing seed grants from IST R&D fund for prototype development, supplementing manpower requirement in R&D projects and international research travel
- Coordination/liaison with National and International R & D Organizations for potential Academia-Industry collaborations and joint R&D projects. This also involves effective monitoring and

smooth execution of all the funded JRPs sponsored by such R&D Organizations

- Focal point on all HEC's funded projects' related matters. This includes overall correspondence regarding timely submission of research proposals against the grants announced under different research programs (like NRPU, TDF, SRGP, PBAIRP, TTSF, ICRG, GCF, LCF etc.)

- Processing of Approved Supervisor Applications
- Conducting Project Management Review (PMR) meeting to monitor timely completion and also ensuring timely release of regular installments against the funded project(s)
- Drafting & implementation of SOPs, Research Proposals and Deed of Agreements for effective research collaborations with National/International R&D Organization(s)
- Preparation and submission of a complete duly signed annual HEC's ORIC Assessment Report/ Scorecard used for maintaining the ORIC active status for obtaining ORIC'S share from future funding
- Correspondence with Pakistan Science Foundation (PSF) for obtaining Travel Grants, Survey Grants and R&D

projects etc.

- Enhancing the scope & pace of R & D related work through the established departmental R&D Cells
- Overall coordination of all professional commitments of the department with and through respective/ concerned ORIC officials for effective management
- Besides internal funding, the section has successfully attracted a huge amount of R&D funding from the following donor agencies under different programs:
 - Pakistan Air Force (PAF)
 - British Council under HEC's ICRG Program
 - Chinese Academy of Sciences
 - Belt and Road Aerospace Innovation Alliance (BRAIA)
 - Deutsche Forschungsgemeinschaft

University-industry Linkages (UIL)

UIL section at ORIC serves as the point of contact for national R&D organizations, other Academia, Industry, and national and international donor agencies to foster stakeholder collaboration for joint industrial R&D initiatives, technology transfer and commercialization of Intellectual Property.

UIL primarily focuses on to bridge the gap between Academia and Industry. In pursuance of so, the section extends maximum possible facilitation to IST faculty and researchers for industry-

focused research, collaborative projects and acquiring hands-on technical experience. Numerous R&D projects have been initiated on account of licensing technologies to the Industry. While, several technology transfer endeavors are underway with renowned engineering firms, like, TeReSol, ABM SATUMA, UHealth International Hospital, Joyn, SoluNox and many other industrial partners. IST UIL has also established close linkages/MoUs with chamber of commerce(s) to bridge with industrial partners for joint collaborations

Business Incubation Center (BIC)

Business Incubation Center (BIC) was established at IST in partnership with Higher Education Commission (HEC) with an aim to create a new breed of entrepreneurs, who believe in their passion and aspire to become a job creator rather than a job seeker.

BIC provides a supportive entrepreneurial environment and infrastructural support to IST faculty, students and alumni to reinforce and commercialize their innovative ideas by launching their own startup companies. The main goal of IST BIC is to develop successful startup companies those are sustainable and can compete in national and international markets.

To develop and inculcate a culture of innovation and entrepreneurship among IST faculty and students, various initiatives have been

launched through the platform of IST BIC. These initiatives include IST Business Acceleration Program (IST BAP), interaction with seasoned entrepreneurs, guest speaker sessions, seminars / workshops, ideas competitions and participation in various business plan competitions.

BIC rolled-out IST Business Acceleration Program in 2017. It is an intense six-months acceleration program which provides a launching platform, mentoring and coaching, business development services and enterprise management support to IST students and faculty to launch their own technology based startups. The BIC is also mandated to organize various internationally accredited Business Plan and Ideas competitions like, Pakathone, ActInSpace, and Hult Prize On Campus and Impact Summit.

In collaboration with TiE Islamabad, an entrepreneurial society, named as IST Entrepreneurial Society (IES) is also functioning at IST. IES is being managed by IST students and is commissioned with to organize various entrepreneurial events, Business Plan competitions, guest speaker sessions and outreach programs.

IST BIC enjoys kinships with different national and international entrepreneurial entities across the globe. Some of the partnering organizations include TiE Islamabad, Rawalpindi and Islamabad Chambers of Commerce &

Industries, International Labor Organization (ILO), STEDEC, Cambridge Advisors Network (CAN), JumpStart Pakistan, OPEN Islamabad and Hult Prize to name a few.

Technology and Innovation Support Center (TISC)

Technology and Innovation Support Center (TISC) is a subsidiary of IST ORIC and was being established at IST in collaboration with World Intellectual Property Office (WIPO), Higher Education Commission (HEC) and Intellectual Property Office (IPO-Pakistan).

TISC is primarily responsible to determine the patentability of inventions, provide assistance in drafting patent applications and exclude patent infringements. It facilitates our faculty, researchers, inventors, innovators and entrepreneurs to manage and protect their Intellectual Property Rights (IPRs). IST TISC also takes pride to mention that the core services are not only offered to IST Faculty & Researchers, but are also rendered to National R&D organizations and industries. The center provides them with access to high-quality technology information and prior art searching. Alongside, awareness seminars and trainings on the importance of IPRs in commercialization of technologies are being organized at TISC. It is worth mentioning that, IST TISC is a part of WIPO Directory of TISCs.

Eligibility for MS Programs

A candidate seeking admissions to a MS program at IST must meet the following criteria:

- BS/ BE/ equivalent (16 Years of education) with strong background in relevant discipline with minimum CGPA \geq 2.00 out of 4.00 or \geq 60% marks (where CGPA not available) from HEC and PEC recognized (where applicable) Institute/University or from Foreign Institute/University of good repute.
- GAT (General) conducted by NTS in the relevant field of study with \geq 50% marks or HAT (General) conducted by HEC in the relevant field of study with \geq 50% marks or GRE International (General) conducted by ETS, USA, with minimum score as Quantitative: 145, Verbal: 145, Analytical: 3.5

The IST institutional code to receive GRE scores is 1758

Eligibility for PhD Programs

A candidate seeking admission to a PhD Program, must meet the following eligibility criteria:

- MS/ M.Phil/ equivalent (18 Years of education) with a strong background in relevant discipline with minimum CGPA 3.00 out of 4.00 or First Division (where CGPA not available) from HEC/PEC recognized Institute/University or from Foreign Institute/University of good repute
- Valid GAT (General) conducted by NTS in the relevant field of

study with \geq 60% score or Valid HAT administered by the Education Testing Council (ETC-HEC) in the relevant field of study with \geq 60% score or GRE International (General) conducted by ETS, USA, with minimum score as Quantitative: 145, Verbal: 145, Analytical: 3.5 or Valid GAT (Subject) conducted by NTS in the relevant field of study with \geq 60% score or Minimum 60% marks in test equivalent to GRE/ HAT General/ Subject conducted by the Higher Education Institution (HEI).

- The IST institutional code to receive GRE scores is 1758.

Application

Application forms must be submitted online along with desired documents at IST's website: www.ist.edu.pk

Note

- Applicants will be allocated an application ID at the submission of online Application Form for admission in IST
- Applicants are required to upload final result card/ transcript/ degree/ equivalent of highest qualification (16 or 18 years of education) with online application form
- Merit lists of short listed candidates will be posted on IST website therefore applicants are required to keep visiting IST website after closing date of applications to download their computer generated offer letter

and other documents

Selection Procedure for MS applicants

Admission in MS programs of IST shall be granted absolutely on merit which will be determined on the basis of marks obtained in the following examinations, and according to the weightage mentioned against the respective examination:

For MSc (02 years) Students*:

• SSC/equivalent	10%
• FSc/equivalent	10%
• BSc/equivalent (02 years)	20%
• MSc/equivalent (02 years)	20%
• Entry Test	40%

*These applicants can apply for non-engineering programs only

For BSc/BS/BE (04 years) Students:

• SSC/equivalent	10%
• FSc/equivalent	10%
• BSc/BS/BE equivalent (04 years)	40%
• Entry Test	40%

Selection Procedure for PhD applicants

Admission in PhD programs of IST shall be granted absolutely on merit which will be determined on the basis of marks obtained in the following examinations, and according to the weightage mentioned against the respective examination:

For MSc (02 years) Students*:

• SSC/equivalent	05%
• FSc/equivalent	05%
• BSc/equivalent (02 years)	10%
• MSc/equivalent (02 years)	10%
• MS/M.Phil/equivalent	30%
• Entry Test	40%

For BSc/BS/BE (04 years) Students:

- | | |
|--|-----|
| • SSC/equivalent | 05% |
| • FSc/equivalent | 05% |
| • BSc/BS/BE/equivalent (04 years) | 20% |
| • MS/M.Phil/equivalent | 30% |
| • Entry Test | 40% |
| • Interview/ Presentation | |
| • Approval of Departmental Board of Graduate Studies (DBGS) | |
| • Any other criteria defined/ set by concerned department for the shortlisting of PhD applicants | |

Important

- An application for admission shall not be considered without the deposit of application processing fee and unless submitted on the prescribed online admission form and completed as required
- Fee status of applicant will be updated at online application form after the deposit of fee in any online HBL branch
- Order of preference of discipline once made is NOT changeable
- The programs mentioned in this prospectus are expression of intent only. The institute reserves the right to discontinue, or make amendments in any of its program or its portion depending on the availability of necessary resources
- Applicants who fail to deposit fee with in specified due date mentioned on fee challan/ offer letter and in email shall be considered to have forfeited their chance for admission
- Applicants who fail to report for registration on the specified date shall be considered to have

forfeited their chance for admission

- Original certificates of all examinations must be produced/submitted at the time of registration
- IST is the final authority to interpret the rules & regulations written in prospectus/student hand book/IST website or anywhere else. Students are not allowed to infer the meanings based on self-interpretations. Similarly, in situations where existing rules & regulations are found silent/unavailable, the decision made by IST will be the final which can't be challenged anywhere else
- If any document received is later found to be false or forged the applicant shall not be considered for admission, and if already a student at the Institute, he /she shall immediately be expelled and disciplinary action would be initiated. Similarly if a student is found not meeting the eligibility criteria mentioned in advertisements/prospectus/IST website, his/her admission shall immediately be cancelled
- In case of expulsion / suspension from the Institute, admission fee and other dues shall not be refunded
- The Admissions Committee reserves the right to cancel or refuse admission to any applicant without assigning any reason
- Applicant is not eligible to claim for any refund or document

without submission of duly signed No Demand Certificate.

**Merit Scholarships for MS Students**

IST awards merit scholarships to high achievers on the basis of the results of each semester as per existing policy.

Note: A student obtaining scholarship/ sponsorship from any source will not be considered for merit scholarship or any other scholarship offered/ announced by IST.

Local Students Fee Structure

MS/PhD Programs

One Time Charges	(Pak Rs)
Admission Fee	25,000/-
Endowment Fund	7,000/-
Library Development Fund	7,000/-

Per Semester Dues	Regular Semester (Pak Rs)
Tuition Fee	73,205/
Service Charges	4,400/-
Safe/Smart Campus Charges	2200/-
Total of Per Semester Dues	79,805/-

Optional Charges Per Semester

Hostel Charges	55,000/-
Transport Charges	As per actual
Locker Rent	1000/-

Continual Enrollment Fee per semester

After 4th/6th semester of MS/PhD Programs=All Service Charges + 1 Cr. Hr. Fee + Fee of any Registered Course
(Rs. 6,000 + Rs. 10,000 = Rs. 16,000 + Fee of any Registered Course)

NOTES

- Repeat/Add Course Fee will be Rs 10,000 per credit hour
- All Fees/ Charges are subject to change from time to time
- Charges are applicable only if services are offered by IST
- All Govt. Taxes will be charged as notified by FBR
- Health Insurance for student may be arranged by the Institute and charges / Premium will be charged as per actual.
- Student ID Card Fee is Rs 1000/-
- Application processing Fee (non-refundable) is Rs. 3000
- Freeze charges are Rs. 10,000 per semester

International Students Fee Structure

MS/PhD Programs

One Time Charges	(US \$)
Admission Fee	2,000/-
Endowment Fund	250/-
Library Development Fund	250/-

Per Semester Dues	Regular Semester (US \$)
Tuition Fee	4,675/-
Service Charges	275/-
Safe/Smart Campus Charges	275/-
Total of Per Semester Dues	5,225/-

Optional Charges Per Semester

Dormitory Charges	US \$ 600/-
Transport Charges	As per actual
Locker Rent	1000/-

Continual Enrollment Fee per semester

after 4th/6th semester of MS/PhD Programs = All Service Charges + 1 Cr. Hr. Fee + Fee of any Registered Course (US \$ 500 + US \$ 1,320 = US \$ 1,820 + Fee of any Registered Course)

NOTES

- Repeat/Additional Course Fee @ US \$ 650/- per credit hour will be charged.
- All Fees/ Charges are subject to change from time to time.
- Charges are applicable only if services are offered by IST.
- All Govt. Taxes will be charged as notified by FBR.
- Health Insurance for student may be arranged by the Institute and charges / Premium will be charged as per actual.
- Student ID Card Fee is Rs 1000/-
- Application processing Fee (non-refundable) is US \$ 150/- through direct remittance in IST Bank Account.
- Freeze charges are US \$. 1000/- for each semester.

Registration

- Before the commencement of classes of each semester, students are required to register themselves. Registration encompasses approval of course from respective academic department/advisor and payment of all dues. A student shall not be considered to have been registered for the semester unless all dues have been paid.
- Hostel accommodation shall only be provided to students after registration.
- Every student must update his/her personal information shown in student portal at the start of every semester.



Fine for Late Payment

Fine will be charged on late payment of fee after due date as per following timeline:

Timeline	%age of Fine
From 1st – 15th day after due date	5 %
From 16th day after due date	10%

Note: A Students will only be allowed to sit in classes/exams after clearance all outstanding dues along with fine if any.

Mode of Payment

Payment of fees can be made through online Transfer/Bank Draft/Pay order against the fee challan issued at any online branch of HBL (Nationwide).

Note: Cheque and cash are not acceptable.

Fee Refund Policy

- The date of request for fee refund claims will be considered from the date of receipt of application through email at refund@ist.edu.pk
- From Registration, all students are required to complete NDC to process the refund of dues (if any) as per fee refund policy
- Tuition Fee, service charges, Safe/Smart Campus Charges, Endowment Fund, Library Development Fund and ID Card Fee are refundable within 15 days of convene of classes on a pro rata basis as given below. No refund shall be admissible after 15 days of convene of classes either one joins IST/avails facilities or not.

Timeline for Refund of Compulsory Fees	%age of Refund
Up to 7th day of convene of classes	100 %
From 8th – 15th day of convene of classes	50%
From 16th day of convene of classes	0 %

- If admission is offered after commencement of classes, date of commencement of classes will be considered as mentioned in offer letter.
- Adjustment of student liability from 2nd Semester and onward will be based on classes attendance & facility will be charged as per actual. Application will only be entertained on the verification by concerned HoD and approval of Registrar.
- In case of Admission cancellation in 1st semester cheque of fee refund will be issued in the name of student's father/guardian.
- 100% dues will be refunded in case where student could not attain requisite marks/grade for admission as prescribed by the institute. However

Fee Structure

Optional Charges will be deducted as per actual usage of facility based on 4.5 Month/Semester. This policy is applicable on fresh admission only.

- In case of semester freeze, fee once deposited will be adjusted in next semester as per freeze policy after re-joining the student. If student wants to leave the institute after freezing his/her semester, then dues will be refunded according to refund policy present at the time of freezing the semester.
- Hostel Charges are refundable within 30 days of registration on a pro rata basis as given below. No refund shall be admissible after 30 days of registration either one joins IST/avails facilities or not. However, refund will be calculated based on the date of application or date of leaving the facilities whichever is later.

Timeline for Refund of Optional Dues	%age of Refund
From 1 st to 7 th day of Registration	90 %
From 8 th to 15 th day of Registration	75%
From 16 th to 21 st day of Registration	50%
From 22 nd to 30 th day of Registration	25%
From 31 st day of Registration	0%

- 100% optional dues will be refunded if application is received before the registration day.
- During continual enrollment, a student can avail monthly hostel facility maximum up to two months. Otherwise S/he will have to pay full semester charges.

MS ACADEMIC REGULATIONS**The Academic Program**

The Master of Science in Engineering is a two years program. There are two semesters in each academic year, with a total of four semesters. Each semester is of 19 weeks duration. There are 17 weeks of classes. After attending classes for 17 weeks, students are to take final examination which is carried out in the 18th and 19th week.

Degree Requirements

The requirements to earn a degree of Master of Science are:

- Completion of the number of credit hours mentioned against each discipline, with a Cumulative Grade Point Average (CGPA) of 3.00 or more in coursework and a minimum of 'B' grade in thesis (6 credit hours)
- There shall be no unresolved failing 'F' grade, W, WSA, WMI, WDA or 'I' grade left during the program
- Passing of relevant admission test defined by IST
- Submission of at least one first authored research article from thesis related work in HEC recognized journal preferably JQRS recognized journal, quality conference or JST (Journal of Space Technology)
- Thesis can be registered after completion of 18 credit hours of coursework but final defense will not be held unless student has CGPA ≥ 3.00 in 24 credit hours of coursework
- Passing of a non-credit "Research Methodology" course of three credit hours (applicable from batch intake Fall 2018 and onwards)
- All degree requirements are to be completed in a maximum duration of 4 years. For MS students who have completed 4 semesters (2 years) but their degree requirements have not yet completed and are enrolled for 5th semester will be charged continual enrollment fee for all subsequent semesters
- No degree will be awarded if all degree requirements are not completed within 4 years from the date of start of 1st semester (duration of zero semester is not included)

- A student shall be registered continuously for the entire duration
- Any other requirement approved by the competent authority as and when required

Credit Hours

MS students are required to complete following credit hours to earn MS degree:

Aerospace Engineering	30
Electrical Engineering	30
Computer Science	30
Materials Science & Engineering	30
Mechanical Engineering	30
Remote Sensing & Geo-Information Science	30
Mathematic	30
Physics	30

ACADEMIC EVALUATION:

A student's academic progress/standing is determined and monitored through the following modes of evaluation.

Assignments

These are the problem sets or projects to be completed independently.

Quizzes

At least two unannounced quizzes per credit hour of up to 5 to 10 minutes duration.

Reports/Projects

These are reports to be prepared on the basis of assignments/projects.

One Hour Tests (OHTs)

These are announced tests of 50 minutes duration. Two OHTs are taken for each course in a semester.

Finals

These are announced tests of a maximum of three hours duration for each course of a semester during the 18th and 19th week

Conduct of Examination

- There is no choice of questions in quizzes, OHTs and finals
- The award of course grade and Semester Grade Point Average (SGPA) is governed by the grading regulations

Monitoring and Performance:

SGPA/CGPA will be the primary measure of academic performance and standing:

If Cumulative GPA is 3.00 or more	Good Standing
If first or any onward semester CGPA less than 3.00	Temporary Enrollment
Receives "F" grade in more than 6 credit hours OR Receives "F" grade in a repeat course (either repeated for passing of "F" grade or repeated for improvement of grade) OR Fails to achieve at least 3.00 CGPA in coursework OR Fails to clear GAT before starting of 3rd semester	Dropout

Grading System

Absolute Grading/Relative Grading System

It is the prerogative of the teacher to decide to use absolute or relative grading for the evaluation.

The following table shows thresholds for all grades. If absolute grading is used the range of marks and grade earned there of are also given in the table.

Interpretation	Grades	Marks
Excellent	A	$85 \leq \text{marks} \leq 100$
	A-	$81 \leq \text{marks} < 85$
Very Good	B+	$77 \leq \text{marks} < 81$
	B	$73 \leq \text{marks} < 77$
Good	B-	$69 \leq \text{marks} < 73$
	C+	$65 \leq \text{marks} < 69$
Passing Grade	C	$61 \leq \text{marks} < 65$
Fail	F	$\text{marks} < 50$
Voluntary Withdrawal	W	
Withdrawn due to Short Attendance	WSA	
Withdrawn due to Medical Illness	WMI	
Withdrawn on recommendation of Disciplinary Committee	WDA	

Grade Point Average (GPA)

GPA is calculated by using following formula:

$$\text{GPA} = \frac{\text{Sum of (Credit hours x grade points)}}{\text{Sum of Credit hours}}$$

Semester GPA is calculated by multiplying the grade points earned in a course with the number of credit hours of that course, taking the sum of such products for each course of the semester and dividing the sum by the total number of credits of the semester. GPA is rounded off to two decimal place by taking into consideration 9 digits after the decimal. Similarly, cumulative GPA is calculated for all the courses in all semesters attended and rounded off accordingly.

Grade "F": Fail

Grade "F" is awarded to a student in a course for not demonstrating adequate performance. Any such course is required to be repeated by the student when offered the very next time.

Grade "I": Incomplete

Grade "I" is awarded to a student who is unable to take the final examination of a course due to extreme circumstances. Any such student is required to take the final examination of that course within six weeks of the approved results by FBS, provided all the other requirements of the course are completed. If a student fails to appear in examination within six weeks, "I" grade will be converted to "F" grade.

Number of Repeat Courses

- MS student can register a total of three repeat courses during entire MS program which include the following:
 - Repeat attempt for passing of "F" grade
 - Repeat attempt for improvement of grade (latest grade earned will be counted towards CGPA)
 - Linkage of elective course for the purpose of improvement of grade (latest grade earned will be counted towards CGPA)
- "F" grades in maximum six credit hour courses are allowed during entire MS program. A student will be dropped from MS program if he gets "F" grade in more than six credit hour courses

Repeat Course

- Course repetition is allowed for students seeking to improve grades including “F” grades which are mandatory. However, only one attempt per course and a total of three repeats are permissible in the academic program. The latest grade earned shall be considered for computation of cumulative GPA. A letter “R” will be affixed against the course attempted the first time, and symbol # will be affixed with the grade earned on the repeat attempt on the transcript
- Student has to formally apply for a repeat course at the time of registration of course with the approval of HoD otherwise his course will not be linked and would be considered as a non-credit course
- In order to improve a grade including “F” grade, a student can either repeat the same course OR can register any other elective course other than core/mandatory course for which student has to formally intimate in writing at the time of registration of course for linking it with the existing elective course. Such elective course will replace the course in which a student got “F” grade/grade improvement. Both the courses will remain listed in the main body of the transcript. The later result will be counted towards CGPA. A special symbol will be used to show the linkage of such courses in the transcript
- An elective course can be linked with only one elective course during entire MS program
- The grades on transcript will reflect that the student has repeated the course
- “F” grade in a repeat course (either repeated for passing of “F” grade or repeated for improvement of grade) will render the student dropped out from MS program
- The students will only be allowed to repeat a course if the seats are available in a classroom after admitting the students of a regular batch. The preference will be given to the students who have lower grades over the students who have higher grades, if the number of

students exceeds the capacity of a classroom

- Students will incur re-registration charges for repeat courses
- The students, who have repeated any course, are ineligible to get academic medals and merit certificates
- W, WDA, WSA and WMI are not counted as repeat courses

Non-credit course

A non-credit course will be registered by a student after his written request in the start of the semester if a student desires to study such a course. A student is also allowed to change the status of a course to a non-credit course before the withdrawal date mentioned in the academic calendar. Such courses will be listed separately at the bottom of the main body of the transcript. These courses will not be counted towards CGPA. Additional course(s) other than approved course plan (24 credit hours) will be considered as non-credit course(s). Requests to change course status (after specified timeline) will not be considered later at any stage of student's degree program. Fee for non-credit course(s) will be charged as credit course(s).

Replacement of Elective Courses

If a student wishes to replace an elective course with another elective course, this replacement will be considered as “repeating the course” and will be counted towards the count of repeat courses. Similarly, “F” grade in an elective course that got replaced by another elective course will still contribute towards the “F” credit hour limit.

Grade “W”: Withdrawn

Students may withdraw courses in a semester according to the dates mentioned in academic calendar. The request for withdrawn courses shall be made with the approval of the academic advisor/HoD on the prescribed form. Fee

Academic Regulations

paid for these courses will not be reimbursed. The courses will be required to be repeated by the students whenever offered the very next time.

Interpretation	Grades
Voluntary Withdrawal	W
Withdrawn due to Short Attendance	WSA
Withdrawn due to Medical Illness	WMI
Withdrawn on recommendation of Disciplinary Committee	WDA

Add/Drop Course

Students may add or drop courses in a semester according to the dates mentioned in academic calendar. The request for add or drop courses shall be made with the approval of the academic advisor on the prescribed form.

Attendance

Students are required to be regular and punctual. A student with less than 80% attendance in a course shall not be allowed to sit in the final exam of that course and a "WSA" grade will be awarded. Minimum 80% attendance is mandatory in a repeat/non-credit course as well.

Semester Freeze

An MS student may freeze studies for at most two regular semesters according to the dates mentioned in the academic calendar, based on medical grounds or other genuine reasons. However, the student cannot apply for freeze in the 1st semester. The student will lose his/her registration from the university roll in case of failure to rejoin/report during the stipulated semester he/she is supposed to rejoin. IST will not make any special arrangements for his/her remaining studies. No extra time will be given and student will have to complete all degree requirements within the maximum time allowed by IST. Student will apply for semester freeze on prescribed form along with undertaking available on IST website. After approval of respective HoD and Dean IST, student will pay

the prescribed semester freeze fee and submit the challan in Finance Office. Admissions Office will update the student status in AMS after confirmation by Finance Office.

Semester Freeze after Due Date

An MS student who is unable to continue the semester due to medical reasons can have the semester frozen with the semester fees carried forward even after elapse of the semester freeze deadline, provided the student's medical condition and the fact that the student is unable to continue studies is verified by a physician on the IST panel.

GAT Freeze

IST gives 1st semester relaxation to all MS students to clear their GAT if not cleared at the time of admission. Their 2nd semester will be frozen, and no further relaxation will be accorded, irrespective of any eventuality. They will be dropped out from the respective degree programs if they fail to clear GAT before starting of 3rd semester.

Readmission

A student dropped-out on academic basis, may apply for readmission through the regular admission process with the subsequent intake.

Academic Integrity

Academic integrity is maintained strictly. A zero-tolerance policy is enforced for academic dishonesty. Any such case is referred to the Disciplinary Committee. The committee after due process can award major or minor penalty. The student has the right to appeal against the decision to VC (IST), within 15 days of serving of decision of disciplinary committee. The decision taken by the VC (IST) will be final and binding.

Conduct and Discipline

Good conduct and discipline is expected of all students of the Institute. Any case of misbehavior or indiscipline is dealt strictly. If a student's registration is ever cancelled on

disciplinary grounds, the student shall be ineligible for readmission to the Institute.

PhD ACADEMIC REGULATIONS

Minimum Requirements for the Award of PhD Degree

The minimum requirements for the award of the Ph.D. degree are given below:

- Successful completion of a minimum of 42 credit hours which includes: (1) 18 credit hours of core and elective graduate level coursework; and (2) 24 dissertation research credits registered for and completed as Thesis phase 1, 2, 3 and 4
- Considering the specialization requirement of the PhD program, the DBGS of a particular department may suggest/specify additional non-credit courses to the enrolled PhD students. GPA of these non-credit courses will not be counted towards calculation of CGPA
- Passing of relevant admission test defined by IST
- Completion of non-credit pass/fail based "Research Method" course with a pass (60% marks) before the registration of Thesis Phase-I
- Completion of coursework with a minimum of 3.00 CGPA
- Successful Completion of Ph.D. Comprehensive Examination
- PhD Proposal Defense to be completed within 1st six semesters of the registration into PhD Program
- Review and approval of written PhD thesis document by field Expert(s)
- Publication of first-authored research article(s) (relevant to PhD research work) of required categories in HEC-Journal Recognition System (HJRS) ranked journals
- Approval of the written PhD Thesis document by the Dissertation Defense Committee
- Final Thesis Defense: Passed with 60% marks
- For the award of PhD degree, a candidate must have secured at least 60% in each thesis phase and its requisite components including coursework, proposal

defense, and approval of dissertation document by internal and external experts/reviewers and public defense of dissertation. Failure to maintain the minimum satisfactory performance (60%) during any thesis phase and its associated requirement will restrict student's transition to next phase

Comprehensive Examination

- Comprehensive Exam will be taken after successful completion of PhD coursework with minimum 3.00 CGPA
- Academic departments are suggested to conduct the comprehensive exam within 6-months after the completion of student's coursework
- Comprehensive exam may be conducted twice a year, 1st in Spring semester (mid-April) and 2nd in Fall semester (mid-November)
- The comprehensive exam will comprise of written and oral components
- The oral examination will be scheduled within three weeks after the successful completion of the written exam. Only those students who pass the written exam will be eligible to appear in the oral exam
- A student who fails any component (written/oral) of the comprehensive exam is required to retake failed component of the examination during the subsequent administration of the examination
- A student is allowed to fail any component (written/oral) of the examination only once. Failing any component twice will result in automatic termination of the student's registration of the program

Dissertation Research Credit Hours

- For the award of the PhD degree, PhD student is required to complete minimum 24 credit hours of dissertation research
- Thesis credit hours will be registered as Thesis Phase-1, Thesis Phase-2, Thesis Phase-3 and Thesis Phase-4
- The credit hours' limit for each Thesis Phase is 6
- The successful completion of comprehensive exam is

requisite prior to register for Thesis Phase-1, however, Thesis Phase-2 will be registered after successful defense of Synopsis and provision of DBGS minutes

- In case a student's work is evaluated as Continuous (CN), he/she may get six months (one-time extension) to complete pending tasks. However, failure to make any progress after the six months' extension will require the candidate to re-enroll for that semester
- A student must have secured at least 60% marks in each thesis phase. In case of failure during any thesis phase will restrict student's transition to next phase
- In case, a student's performance is evaluated as unsatisfactory during any particular Thesis Phase, he/she has to repeat that Thesis Phase. Failure to get satisfactory performance grade ($\geq 60\%$) more than twice during entire Thesis Research Phases will result in termination of the program

Proposal Defense (Synopsis)

- The required coursework, comprehensive exam, and defense of synopsis/research proposals should be completed within 1st six semesters of the registration into a PhD program. In case of noncompliance, the registration shall be cancelled and transcripts for completion of coursework may be issued to the student
- The Dissertation Proposal Defense should be scheduled once the student has successfully passed the Comprehensive Exam
- The successful completion of the Proposal Defense ($\geq 60\%$) is pre-requisite for the advancement to doctoral candidacy
- If a student delays his/her proposal defense beyond two semesters after passing the comprehensive exam, the DBGS reserves the right to decide whether to:
 - Allow the student to remain in the program on probation with a condition to defend dissertation proposal in the suggested time period, provided it does not exceed the time bar of 1st six semesters OR
 - Terminate the student's program of study for not

meeting the requirements

Dissertation Evaluation

The PhD dissertation must be evaluated by:

- At least two external experts who shall be:
 - PhD faculty member from the world top 500 universities ranked by the Times Higher Education or QS World Ranking in the year corresponding to dissertation evaluation year OR
 - Pakistan-based Distinguished National Professors, Meritorious Professors from any national university; or professors from top universities ranked by HEC; or professors from any Pakistani University having a minimum H-Index 30 for Sciences, 15 for Social Sciences or 8 for Art & Humanities as determined by Web of Science OR
- At least one external expert qualifying any one of the conditions mentioned at 'a' above if the PhD candidate publishes dissertation research in a peer-reviewed journal that is classified by the HEC in category W for Sciences and X or above for Social Sciences
 - The DBGS of the concerned department will suggest / nominate the external expert(s) for the evaluation of the dissertation. However, the authority to finalize the selection of the external experts from the nominations will rest with GSRC
 - The positive feedback ($\geq 60\%$) of external expert(s) is requisite for the approval of the dissertation
 - In case one of the two external experts declare the dissertation rejected, the dissertation will be submitted to a third external expert for the evaluation. Failure to get the approval of the dissertation from the third external expert will result in termination of the student's degree program.
 - In case dissertation is being evaluated by only one external expert and he/she declares it as rejected, PhD dissertation will be sent to second

external expert, however, failure to get approval from second expert will result in termination of the student's PhD degree program.

Public Defense of Dissertation

- Following the approval of the dissertation by external expert(s), the public defense of the dissertation will be conducted
- The dissertation defense will be evaluated as:
 - Pass ($\geq 60\%$)
 - Pass with minor changes (51% - 59%)
 - Pass with major changes (50%)
 - Rejected ($< 50\%$)
- In case of rejection, the student will be required to retake the defense within six months after the first defense attempt. Failure to get satisfactory performance grade ($\geq 60\%$) for the second defense attempt will result in termination of the student's degree program

Research Publication

For the award of PhD degree, a PhD researcher shall be required to publish research article(s) meeting the following criteria (ranked by HJRS):

- At least:
 - One research article in W category journal or two research articles in X category journals, for Science disciplines
 - One research article in X category journal or two research articles in Y category journals, for Social Science disciplines
- The PhD researcher shall be the first author of these publications
- The research article shall be relevant to the PhD research work of the PhD researcher
- The article shall be published after approval of the research synopsis
- The article shall be published in a relevant research journal

Duration of PhD Program and Policy for Extension

- The PhD degree shall not be awarded before the completion of three years or six regular semesters and not after completion of six years or 12 regular semesters
- The completion date of PhD degree shall be reckoned with the date of notification of completion of PhD degree. The maximum duration shall be determined from the date of student enrollment (excluding zero semester, if applicable) until the date of the completion notification of the PhD degree
- In case a student fails to complete the program requirements within restricted time (six years), he/she may request for further extension of maximum two years. DBGS may or may not forward the request to GSRC for necessary action
- The GSRC reserves the right to accept or reject requests for extension on case to case basis
- The extension can be granted only for maximum two years. Failing to complete the program requirements within approved extension period will result in termination of the PhD program

Award of Post Graduate Diploma/Certificate

A student who successfully completes coursework and passes the comprehensive examination but is unable to defend a PhD synopsis/research proposal or does not complete the required research for obtaining a PhD degree within the specified timeframe, may be granted a Graduate Level Diploma/Certificate/Transcript or another MS. Such students are allowed to convert PhD into existing MS degree program. SoP of MS program, will be followed and implemented on such students.

Course Repetition and Grade Improvement Policy

- A student may request to repeat any two graduate level approved courses only once during the entire academic program, under specified circumstances with certain restrictions as follows:

- **Restrictions:**
 - To improve his/her CGPA if less than 3.00 (latest grade earned will be counted towards CGPA)
 - To pass an “F” grade course
 - Replacement/Linkage of elective course for the purpose of grade improvement (latest grade earned will be counted towards CGPA)
- **Restrictions:**
 - The grade improvement policy will be applicable to the approved PhD coursework. Students are not allowed to replace core PhD courses with non-core courses or PhD non-core courses (such as electives) with core courses.
 - In either case, the student is required to submit a request form for re-registration of the particular course(s) in subsequent semesters to Admission Office routing through HoD of the concerned department. However, re-registration will depend upon the course-offering schedule (Spring or Fall) of the concerned department.
 - In case of course repetition, the earned grade point average of the revised/repeated course (final attempt) will be considered for the calculation of CGPA. However, grade history of the revised courses will be shown on official transcript.
 - Students will incur re-registration charges for repeat/improve/course replacements.
 - Course replacement will be considered as “repeating the course” and will be counted towards the count of repeat courses. Similarly, “F” grade in an elective course that got replaced by another elective course will still contribute towards the “F” credit hours' limit.

Program Termination

A student's course of PhD program will be terminated under the following conditions if he/she:

- Earns “F” grade in more than three credit hours' coursework
- Receives “F” grade in repeat course (either repeated for passing of “F” grade or repeated for

linkage/improvement of grade)

- Fails to maintain 3.00 CGPA on completion of coursework even after availing two repeat chances for improvement of grades/passing of an “F” grade
- Fails to clear GAT before starting of 3rd semester
- Fails to complete coursework, comprehensive & synopsis defense requirements within stipulated time
- Fails twice in any component (written/oral) of the comprehensive exam
- Receives unsatisfactory progress grade by his/her supervisor in more than two Thesis Phases
- Violates the ethics of academic and research integrity by three consecutive counts of plagiarism
- Research misconduct that include falsification, fabrication and misrepresentation of research data
- Violating university rules
- His/her dissertation evaluation is rejected by two external experts

Add/Drop Courses

Students may add or drop courses in a semester according to the dates mentioned in academic calendar. The request for add or drop courses shall be made with the approval of the academic advisor/Admissions Committee on the prescribed form..

Grade “I”: Incomplete

Grade “I” is awarded to a student who is unable to take the final examination of a course due to extreme circumstances. Any such student is required to take the final examination of that course within six weeks of the approved results by FBS, provided all the other requirements of the course are completed. If a student fails to appear in examination within six weeks after announcement of result/convening of FBS, “I” grade will be converted to “F” grade.

Grade “W”: Withdrawn

Students may withdraw courses in a semester according to the dates mentioned in academic calendar. The request for withdrawn courses shall be made with the approval of

the academic advisor/HoD on the prescribed form. Fee paid for these courses will not be reimbursed. The courses will be required to be repeated by the students whenever offered the very next time.

Interpretation	Grades
Voluntary Withdrawal	W
Withdrawn due to Short Attendance	WSA
Withdrawn due to Medical Illness	WMI
Withdrawn on recommendation of Disciplinary Committee	WDA

Note!

W, WSA, WMI and WDA are not counted as repeat courses. However, there should be no unresolved F grade, W, WSA, WMI, WDA or 'I' grade left during the PhD program. Students will incur registration charges for resolving of any kinds of W grade.

Attendance

Students are required to be regular and punctual. A student with less than 80% attendance in a course shall not be allowed to sit in the final exam of that course and a "WSA" grade will be awarded. Minimum 80% attendance is mandatory in a repeat and non-credit course as well.

Semester Freeze

A PhD student may freeze studies for at most two regular semesters according to the dates mentioned in the academic calendar, based on medical grounds or other genuine reasons. However, the student cannot apply for freeze in the 1st semester. The student will lose his/her registration from the university roll in case of failure to rejoin/report during the stipulated semester he/she is supposed to rejoin. IST will not make any special arrangements for his/her remaining studies. No extra time will be given and student will have to complete all degree requirements within the maximum time allowed by IST. Student will apply for semester freeze on prescribed form along with undertaking available on IST website. After approval of respective HoD and Dean IST, student will pay the prescribed semester freeze fee and submit the

challan in Finance Office. Admissions Office will update the student status in Academic Management System (AMS) after confirmation by Finance Office.

Semester Freeze After Due Date

A PhD student who is unable to continue the semester due to medical reasons can have the semester frozen with the semester fees carried forward even after elapse of the semester freeze deadline, provided the student's medical condition and the fact that the student is unable to continue studies is verified by a physician on the IST panel.

Re-admission

A student dropped-out on academic basis, may apply for readmission through the regular admission process with the subsequent intake.

Academic Integrity

Academic integrity is maintained strictly. A zero-tolerance policy is enforced for academic dishonesty. Any such case is referred to the Disciplinary Committee. The committee after due process can award major or minor penalty. The student has the right to appeal against the decision to VC (IST), within 15 days of serving of decision of disciplinary committee. The decision taken by the VC (IST) will be final and binding.

Conduct and Discipline

Good conduct and discipline is expected of all students of the Institute. Any case of misbehavior or indiscipline is dealt strictly. If a student's registration is ever cancelled on disciplinary grounds, the student shall be ineligible for readmission to the Institute.

Note!

W, WSA, WMI and WDA are not counted as repeat courses. However, there should be no unresolved F grade, W, WSA, WMI, WDA or 'I' grade left during the PhD program. Students will incur registration charges for resolving of any kinds of W grade.

Faculty of Aeronautics & Astronautics**Dr Raees Fida Swati**

Head of Department
PhD Northwestern Polytechnical University, Xi'an, China
Area of Specialization: Structural Design & Analysis

Jamshed Riaz

Professor (Adjunct Faculty)
PhD Georgia Institute of Technology, USA
Area of Specialization: Flight Mechanics, Automatic Control

Muhammad Naeem

Professor
PhD Cranfield University, UK.
Area of Specialization: Gas Turbines Performance (Modelling & Simulation)

Gohar Majeed

Assistant Professor
MS Iowa State University, USA
Area of Specialization: Aerospace Structures, Mechanics of Composite materials, Damage tolerance analysis, Finite Element modeling and analysis

Hayat Muhammad Khan

Assistant Professor
PhD Northwestern Polytechnical University, China
Area of Specialization: Controls, Automation and Robotics

Izhar Hussain Kazmi

Assistant Professor
M. Phil ENSHM, INPG, France
Area of Specialization: Fluid Dynamics

Saad Rifat Qurashi

Assistant Professor
Phd University of Dayton, OHIO USA
Area of Specialization: Fluid Dynamics

Umer Sohail

Assistant Professor
Phd Institute of Space Technology
Area of Specialization: Computational Fluid Dynamics (CFD) Turbo machinery Machine Learning Artificial Neural Networks

Dr Muhammad Wasim

Assistant Professor
PhD University of Engineering and Technology Taxila, Pakistan
Area of Specialization: Control Systems

Dr Mariyam Sattar

Assistant Professor
PhD Beihang University of Aeronautics & Astronautics (BUAA), China
Area of Specialization: Solid Mechanics

Sajid Hussain

Lecturer
MS National University of Sciences and Technology, Pakistan
Area of Specialization: Micro Electromechanical Systems (MEMS).

Fatima Hira

Lecturer
MS Capital University of Science and Technology, Pakistan
Area of Specialization: Engineering Management

Asad Mehmood

Lecturer
MS Institute of Space Technology, Islamabad
Area of Specialization: Experimental Aerodynamics, Renewable Energy

Shuja Ur Rehman

Lecturer
MS Northwestern Polytechnical University, China
Area of Specialization: Aero Vehicle Design

Faculty of Avionics**Dr Israr Hussain**

Professor/ Head of Department
PhD University of Manchester- UK
Area of Specialization: Signal and Image Processing

Dr Abdul Waheed

Associate Professor
PhD The Hong Kong University of Science and Technology
Area of Specialization: Modelling Simulation and Control

Dr Suhail Akhtar

Professor
PhD University of Michigan, Ann Arbor
Area of Specialization: Flight Dynamics & Control

Dr Muhammad Amin

Professor
PhD Queen's University Belfast, UK
Area of Specialization: Antennas for Space and Land Communications

Dr Muhammad Abdul Rehman Khan

Professor
PhD Beihang University, China
Area of Specialization: Information and Communication Systems, Spread Spectrum Communication System

Engr Irfan Majid

Assistant Professor
MS NUST CAE
Area of Specialization: Avionics

Engr Sardar Ahmed

Assistant Professor
MS NUST Islamabad
Area of Specialization: Avionics

Engr Muhammad Zahid Sheikh

Assistant Professor
MS George Washington University, USA
Area of Specialization: Data and Computer Communications

Engr Lal Said

Lecturer
MS Institute of Space Technology
Area of Specialization: Computer Vision, Pattern Recognition

Engr Shifa Nadeem

Lecturer
MS Institute of Space Technology
Area of Specialization: Wireless Communication

Engr Hamail Sultan

Lecturer
MS Institute of Space Technology
Area of Specialization: Wireless Communication

Anila Ali Ahmed

Lecturer
MS COMSAT University of Science and Technology, Islamabad
Area of Specialization: Control Systems

Engr Hafiz Ali Ahmad

Lecturer
MS National University of Science & Technology
Area of Specialization: Control Systems, Power Electronics, Electric Machines & Drives, Electric Vehicles

Faculty of Electrical Engineering and Computer Science**Dr Khurram Khurshid**

Professor/Head of Computer Science
PhD Paris Descartes University, France
Area of Specialization: Machine Learning, Hyper-spectral Image Analysis, Document Image Processing

Dr Qamar-UI-Islam

Professor
Phd. University of Surrey, UK
Area of Specialization: Satellite Communications/ Space Systems

Dr Adnan Zafar

Assistant Professor/Head of Electrical Engineering
PhD University of Surrey, UK
Area of Specialization: Signal Processing for Wireless Communication

Dr Amena Ejaz Aziz

Assistant Professor
PhD Hong Kong Polytechnic University
Area of Specialization: Visible light communication

Dr Benish Amin

Assistant Professor
PhD NUST Pakistan
Area of Specialization: Digital Image Processing

Dr Komal Nain Sukhia

Assistant Professor
PhD NUST Pakistan
Area of Specialization: Digital Image Processing

Dr Rehan Mahmood

Assistant Professor
PhD Beihang University, China
Area of Specialization: Spacecraft Engineering

Dr Syed Ali Irtaza

Assistant Professor
PhD Hanyang University, South Korea
Area of Specialization: Compressed Sensing, Wireless & Mobile Communication

Dr Madiha Tahir

Assistant Professor
PhD GIKI University, Swabi
Area of Specialization: Deep Learning and Evolutionary Algorithms

Dr Bilal Ahmed Khan

Assistant Professor
PhD Bahria University, Islamabad
Area of Specialization: Networks, Technology and Innovation Management

Dr Salma Zaineb Farooq

Assistant Professor
PhD BUAA, Beijing
Area of Specialization: Communication and Information Systems, GNSS

Muhammad Ghayas Uddin

Assistant Professor
M. Phil Punjab University, Pakistan
Area of Specialization: VLSI Design & Fabrication

Saima Siddiqui

Assistant Professor
MS CASE, Islamabad
Area of Specialization: Electronics/ Engineering Management

Tariq Mahmood (Adjunct Faculty)

Assistant Professor
MSc Cranfield UK
Area of Specialization: Computer Design

Engr Ahmed Raheeq Sultan

Lecturer
MS NUST Pakistan
Area of Specialization: Electronic Design, Network Security, Forensics and Cryptography

Engr Faran Mahmood

Lecturer
M.Phil University of Cambridge
Area of Specialization: Systems Engineering, Product Design

Engr Haroon Ibrahim

Lecturer
MS IST, Pakistan
Area of Specialization: Communications, Signal Image Processing

Engr Muhammad Asad (Abroad for PhD)

Lecturer
MS GIK Institute, Pakistan
Area of Specialization: Data Science, Machine Learning and Feature Engineering

Engr Muhammad Jaleed Khan (Abroad for PhD)

Lecturer
MS IST Islamabad
Area of Specialization: Deep Learning, Hyperspectral Image Analysis, Computer Vision

Ali Fahim Khan (Abroad for PhD)

Lecturer
MS NUST Pakistan
Area of Specialization: Signal Processing

Engr Saniya Zafar

Lecturer
MS IST Pakistan
Area of Specialization: Wireless Communications

Tufail Sajjad Shah Hashmi

Lecturer
MS NUST, Islamabad
Area of Specialization: Computer Vision and Artificial Intelligence

Muhammad Nadeem

Lecturer
MS GIKI University, Swabi
Area of Specialization: Artificial Intelligence and Cyber Security

Zil-E-Huma

Lecturer
MS SEecs (NUST), Islamabad
Area of Specialization: Electronics and Control Systems

Muddser Qamer Raja

Lecturer
MS ABASYN University, Islamabad
Area of Specialization: Electrical Power

Usman Ali Afzal

Lecturer
MS SEecs NUST, Islamabad
Area of Specialization: Control Systems and Power Electronics

Aima Zahid

Lecturer
MS Electrical Engineering
Information Technology University of the Punjab
Area of Specialization: RF and Microwave, Nanotechnology

Ammara Yaseen

Lecturer
MS (Data Science)
NED University of Engineering and Technology
Area of Specialization: Data science and Data Visualization

Asia Aman

Lecturer
MS Electrical Engineering
Institute of Space Technology
Area of Specialization: Signals and Image processing

Muhammad Hamza Rafique Bhatti

Lecturer
MS Software Engineering
COMSATS University, ISLAMABAD
Area of Specialization: Deep Learning and Machine Learning

Natiqa Gul

Lecturer
MS Computer Engineering, GIKI
Area of Specialization: Advanced Machine learning and Computer Vision

Reeda Saeed

Lecturer
Masters in Computer Science
Ghulam Ishaq Khan Institute (GIKI)
Area of Specialization: AI in Healthcare

Tayyaba Arshad

Lecturer
MS Data Science
FAST-NUCES ISLAMABAD
Area of Specialization: Natural Language processing & Medical Image processing

Faculty of Materials Science & Engineering**Dr Abdul Wadood**

Head of Department
PhD Tokyo Institute of Technology, Japan
Area of Specialization: Shape memory alloys, Biomaterials

Dr Ibrahim Qazi

Professor
PhD University of Sheffield, UK
Area of Specialization: Electro Ceramics

Dr Syed Wilayat Husain

Professor
PhD University of Connecticut, USA
Area of Specialization: Physical Metallurgy

Dr Anjum Tauqir

Professor
PhD University of Connecticut (USA)
Area of Specialization: Alloy Development

Dr Sajid Ullah Khan

Professor
PhD University of Twente, Netherlands
Area of Specialization: Nanotechnology

Dr Saima Shabbir

Professor
PhD Quaid-i-Azam University, Islamabad
Area of Specialization: Polymer Chemistry

Dr Saad Nauman

Professor
PhD Universite des Sciences et
Technologies de Lille 1 Lille, France
Area of Specialization: Carbon Composites

Dr Abdul Faheem Khan

Professor
PhD Pakistan Institute of Engineering and Applied Sciences,
Islamabad
Area of Specialization: Thin Film Materials

Dr Muhammad Abdul Basit

Associate Professor
PhD Hanyang University, South Korea
Area of Specialization: Thin Film Development for solar Cell
Applications

Dr Muhammad Yasir

Associate Professor
PhD Huazhong University of Science & Technology, China
Area of Specialization: Amorphous Coatings

Dr Muhammad Atiq ur Rehman

Assistant Professor
PhD University of Erlangen Nuremberg
Area of Specialization: Biomaterials

Engr Kashif Naveed

Assistant Professor
MS UMIST, UK
Area of Specialization: Corrosion Engineering

Engr Muhammad Abdul Qadir

Lecturer
MS UET, Lahore
Area of Specialization: Coatings and surface engineering

Engr Muhammad Awais

Lecturer
MS PU, Lahore
Area of Specialization: Composites

Engr Zeeshan Khan

Lecturer
MS PIEAS, Islamabad
Area of Specialization: Materials Science & Engineering

Faculty of Mechanical Engineering**Dr Asif Israr**

Professor/Head of Department
PhD University of Glasgow, UK
Area of Specialization: Dynamics

Dr Muhammad Zubair Khan

Professor
PhD Burnel University, UK
Area of Specialization: Applied Mechanics

Dr Owais ur Rahman Shah

Associate Professor
PhD University of BREST, France
Area of Specialization: Failure in Composites

Dr Muhammad Anwar

Assistant Professor
PhD University of Luxembourg, Luxembourg
Area of Specialization: Fluid and Thermal System

Dr Usama Waleed Qazi

Assistant Professor
PhD UET, Taxila
Area of Specialization: Engineering Management

Dr Muhammad Umer

Assistant Professor
PhD Politecnico Di Torino, Italy
Area of Specialization: Non linear Vibration Dynamics and Machine Design

Dr Talha Irfan Khan

Assistant Professor
PhD KoC University, Turkey
Area of Specialization: CFD and Biomedical

Dr Yumna Qureshi

Assistant Professor
PhD ENSTA Bretagne, France
Area of Specialization: Real Time Structural Health Monitoring

Dr Naseem Ahmad

Assistant Professor
PhD Harbin Engineering University, China
Area of Specialization: Aerodynamics of Turbomachinery, Turbine Blade Cooling, Flutter and Computational Fluid Dynamics

Engr Muhammad Azfar Jamal

Lecturer
MS IST, Islamabad
Area of Specialization: Mechanical Design and Additive Manufacturing

Engr Ruqia Ikram

Lecturer
MS IST, Islamabad
Area of Specialization: Mechanical Design and Analysis

Engr Sahibzada Shahroze Umar

Lecturer
MS University of Houston, USA
Area of Specialization: Computational Fluid Dynamics

Engr Syed Muhammad Mansoob Bukhari

Lecturer
MS IST, Islamabad
Area of Specialization: Mechanical Design and Analysis

Engr Saad Akram

Lecturer
MS IST, Islamabad
Area of Specialization: Mechanical Design and Analysis

Engr Babar Ashfaq

Lecturer
MS International Islamic University, Islamabad
Area of Specialization: Mechanical Design and Analysis

Engr Samia Fida (Abroad for PhD)

Lecturer
MS IST, Islamabad
Area of Specialization: Mechanical Design & Analysis

Faculty of Space Science**Dr Mujtaba Hassan**

Assistant Professor / Head of Department
PhD TSINGHUA University, China
Area of Specialization: Climate Variability and Change; Extreme Events; South Asian Summer Monsoon Dynamics; Regional Climate Modeling; Hydrological Modeling; Climate Change Impact Assessment on Water Resources; Air Pollution Monitoring; Aerosol Climate Interaction

Dr Ali Hussain (Abroad for Postdoc)

Professor
PhD University of Ulsan, South Korea
Area of Specialization: Piezoelectric materials, synthesis, characterization and their applications

Dr Najam Abbas Naqvi

Associate Professor
PhD Northwestern Polytechnical University (NPU), China
Area of Specialization: Spacecraft Dynamics and Controls, Global Navigation Satellite System (GNSS)

Dr Saleem Ullah (Abroad for Postdoc)

Associate Professor
Postdoc University of California Santa Barbara (UCSB), USA
Area of Specialization: (Remote Sensing of Vegetation) Remote sensing/GIS, Multispectral and Hyperspectral Remote Sensing

Dr Sajid Ghuffar

Associate Professor
 Postdoc University of St Andrews, UK
 Area of Specialization: Photogrammetry, Computer Vision, Remote Sensing, Machine Learning, Cubesats

Dr Sajid Butt

Associate Professor
 PhD Tsinghua University, Beijing, China
 Area of Specialization: Energy Materials, Functional Materials, Physics of Materials, Advanced Characterization Techniques

Dr Muhammad Shakir

Associate Professor
 PhD Institute of Remote Sensing and Digital Earth Chinese Academy of Sciences Beijing China
 Area of Specialization: Agriculture Remote Sensing, Forestry

Dr Munawar Shah (Abroad for Postdoc)

Assistant Professor
 PhD Shanghai Astronomical Observatory, CAS, China
 Area of Specialization: GNSS ionosphere modelling; GNSS-R; Earthquake Precursors in atmosphere and ionosphere; GNSS Space Weather

Abdul Kabir

Assistant Professor
 PhD GIK Institute of Engineering Sciences and Technology, Pakistan
 Area of Specialization: (Theoretical Nuclear Astrophysics) Nucleosynthesis problem (r-, s-, p- and rp-process), Evolution phases of stars and supernova explosions, Nuclear cross-section, Quantum many bodies interaction, Nuclear abundances, Low and Heavy ions interaction in nuclear physics.

Imran Ali Khan

Assistant Professor
 PhD GC University Lahore, Pakistan
 Area of Specialization: Applications of Electromagnetic Waves in Space Plasmas

Dr Muhammad Usman

Assistant Professor
 PhD NUST, Islamabad
 Area of Specialization: Particle Astrophysics and Cosmology

Dr Saeeda Sajjad

Assistant Professor
 PhD University of Montpellier, France
 Area of Specialization: Physics (Gamma-ray astronomy, High energy astronomy and astrophysics, Imaging Atmospheric Cherenkov Telescopes, Monte Carlo simulations, Gamma-ray bursts)

Ibtehaj Hassan

Lecturer
 MS Institute of Space Technology, Islamabad
 Area of Specialization: Plasma Physics

Maham Siddiqi

Lecturer
 MS Sultan Qaboos University, Muscat, Oman
 Area of Specialization: Gravitational Waves, X-ray Binaries

Waheed Ahmed

Lecturer
 MS University of Innsbruck, Austria / University of Goettingen, Germany
 Area of Specialization: Astronomy and cosmology

Adnan Ashraf

Lab Engineer
 MS Institute of Space Technology, Islamabad
 Area of Specialization: Global Navigation Satellite Systems, Physics

Asad Munir

Lab Associate
 MPhil Quaid-I-Azam University, Islamabad
 Area of Specialization: Particle Physics, Radiation Physics

Shahanshah Abbas

Lab Engineer
 MS Institute of Space Technology Islamabad
 Area of Specialization: Remote Sensing and Geographic Information Science, Computer Engineering

Usama Ahmad

Lab Engineer
 MS Institute of Space Technology, Islamabad
 Area of Specialization: Global Navigation Satellite System (GNSS)

Faculty of Applied Mathematics & Statistics**Dr Muhammad Nawaz**

Associate Professor/Head of Department
PhD Quaid-i-Azam University, Islamabad
Area of Specialization: Applied Mathematics

Dr Salman Ahmad

Professor
PhD Beijing Institute of Technology, China
Area of Specialization: General & Fundamental Mechanics

Dr Asad Ali

Professor
PhD The University of Auckland, New Zealand
Area of Specialization: (Statistics) Inference, MCMC Methods, Gravitational Radiation, Bayesian Spectrum Analysis, Parallel Computing

Dr Maryiam Javed

Associate Professor
PhD Quaid-i-Azam University, Islamabad
Area of Specialization: Applied Mathematics

Dr Muhammad Aqeel

Associate Professor
PhD Beijing Institute of Technology, China
Area of Specialization: General & Fundamental Mechanics

Dr Rahila Naz

Associate Professor
PhD Quaid-i-Azam University, Islamabad
Area of Specialization: Applied Mathematics

Dr Waqas Ashraf

Associate Professor
PhD COMSATS Institute of Information Technology, Islamabad
Area of Specialization: Applied Mathematics

Dr Majid Khan

Associate Professor
PhD Quaid-i-Azam University, Islamabad
Area of Specialization: Cryptography

Dr Ayesha Rafiq

Assistant Professor
PhD Quaid-i-Azam University, Islamabad
Area of Specialization: Group Theory and Generalizations

Dr Danish Ali Sunny

Assistant Professor
PhD University of Stuttgart Germany
Area of Specialization: Applied Analysis/Nonlinear Partial Differential Equations

Dr Salma Riaz

Assistant Professor
PhD Quaid-i-Azam University
Area of Specialization: Bayesian Control Charts

Dr Sadia Saeed

Assistant Professor
PhD Comsats University, Islamabad
Area of Specialization: Computational Mathematics

Dr Erum Zahid

Assistant Professor
PhD Quaid-i-Azam University
Area of Specialization: Survey Sampling & Geostatistics

Dr Khawar Mehmood

Assistant Professor
PhD Abdus Salam School of Mathematical Sciences, GC University Lahore
Area of Specialization: Singularity Theory, Computer Algebra, Commutative Algebra

Dr Umair Ali

Assistant Professor
PhD University of Science, Malaysia
Area of Specialization: Fractional Computational Mathematics

Dr Javeria Ayub

Lecturer
PhD Institute of Space Technology, Islamabad
Area of Specialization: Applied Mathematics & Statistics

Zaheer Ahmed (On study leave)

Lecturer

M. Phil Quaid-i-Azam University, Islamabad

Area of Specialization: Statistics

Amir Rahim

Lecturer

MS NUST

Area of Specialization: Applied Mathematics

Faculty of Humanities & Sciences**Dr Ausima Sultan Malik**

Assistant Professor/Head of Department

PhD Foundation University, Islamabad

Area of Specialization: Applied Linguistics and Literature

Dr Syeda Aysha Bokhari

Assistant Professor

PhD Foundation University, Islamabad

Area of Specialization: Applied Linguistics and Literature

Uzma Nasir

Assistant Professor

M. Phil Air University, Islamabad

Area of Specialization: Applied Linguistics and Literature

Syed Ubaidullah Jamil

Assistant Professor/Academic Coordinator

MS International Islamic University, Islamabad

Area of Specialization: Aqeedah & Philosophy

Sadia Zaheer

Lecturer

M. Phil National Institute of Pakistan Studies (NIPS), Quaid-e Azam University

Area of Specialization: Water Resource Management and Freedom Movement in Punjab

Tamkeen Zehra Shah

Lecturer

MS Foundation University, Islamabad

Area of Specialization: Argumentation Theory and Critical Discourse Analysis

Tehreem Ali

Lecturer

M.Phil Fatima Jinnah Women University, Rawalpindi

Area of Specialization: English Literature

Qurat-ul-Ain

Lecturer

M.Phil Quaid-i-Azam University, Islamabad

Area of Specialization: English Linguistics and Literature

Ifrah Jamil

Lecturer

M.Phil Fatima Jinnah Women University, Rawalpindi

Area of Specialization: Critical discourse analysis

Maj. Gen. Rehan Abdul Baqi, HI (M), (Retd)	Vice Chancellor
Dr Ibrahim Qazi	Dean
Abdul Waheed Kandhro	Acting Registrar
Dr Raees Fida Swati	HOD - Aeronautics & Astronautics
Dr Abdul Wadood	HOD - Materials Science & Engineering
Dr Asif Israr	HOD - Mechanical Engineering
Dr Mujtaba Hassan	HOD - Space Science
Dr Khurram Khurshid	HOD - Computer Science
Dr Adnan Zafar	HOD - Electrical Engineering
Dr Muhammad Nawaz	HOD - Applied Mathematics & Statistics
Dr Ateeq Qureshi	HOD - National Center for Remote Sensing & Geo- Informatics
Dr Israr Hussain	HOD - Avionics Engineering
Farooq Ahmad	Additional Director Administration
Zia Ahmad	Senior Director Human Resource
Engr Hamid Amir SI (M)	Controller of Examinations
Dr Anjum Tauqir	Acting Director National Centre for Failure Analysis
Dr Adul Waheed	Director ORIC and QEC
Tariq Anees Malik	Additional Director Security
Raees Ahmed	Incharge Transport
Waqas Ahmed Malik	Additional Director QEC
Raza Butt	Incharge Student Affairs
Dr Israr Ahmad	Incharge Admissions
Hafiz Muhammad Usman	Deputy Director Hostel
Arshad Minhas	Deputy Director (Acad. Coord)
Syed Muhammad Ali	Incharge Library

IST ISLAMABAD CAMPUS

Institute of Space Technology
1, Islamabad Highway;
Islamabad

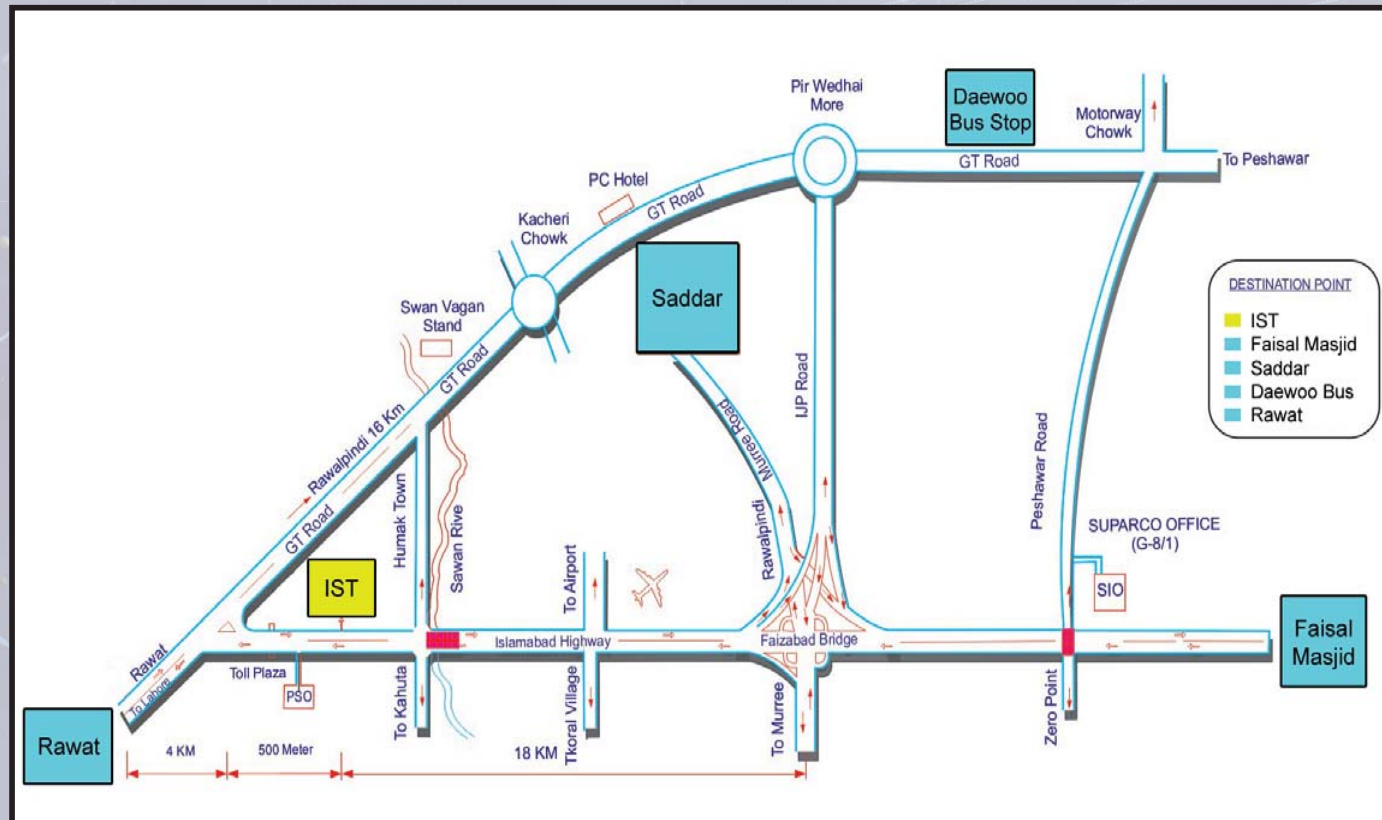



Institute of
Space Technology

Admissions Office
Institute of Space Technology
1, Islamabad Highway; Islamabad

Email: admissions@ist.edu.pk
Website: www.ist.edu.pk

Tel: +92-51-9075100
Fax: +92-51-9273310